

**+ DE 20 AÑOS**  
EQUIPANDO  
**COLECTIVIDADES**



**CATÁLOGO GENERAL / GENERAL CATALOGUE**  
CATALOGUE GENERAL / CATÁLOGO GERAL

MEGABLOK®



+ DE 20 AÑOS  
EQUIPANDO  
COLECTIVIDADES

Estimado cliente,

Me complace dirigirme a ti en esta ocasión para presentarte nuestro nuevo catálogo.

Seguimos ampliando la gama de soluciones con más diseños, productos y posibilidades para el equipamiento de colectividades.

Asimismo, presentamos nuestra nueva web con información ampliada de nuestros productos y empresa, y que agiliza las consultas y el trabajo diario.

En nombre propio y en el de todo el equipo que componemos MEGABLOK queremos agradecer a todos nuestros clientes, proveedores, vendedores y trabajadores el apoyo y confianza recibido durante todos estos años y su contribución a que este proyecto haya sido posible.

Esperamos seguir contando con tu apoyo para seguir creciendo y desarrollando productos juntos; y continuar mereciendo la misma confianza que nos has hecho llegar hasta aquí.

Recibe un cordial saludo.

José Antonio Villaverde  
Gerente  
MEGABLOK, S.A.U.

Dear customer,

I have the pleasure to address myself to you in this occasion, to present you our new catalogue.

We are still amplifying our range of solutions with more designs, products and possibilities for the collectivity equipment.

At the same time, we present our new website with more information about our products and our company, and which will make enquiries and the daily work easier.

In my own name and in the name of the whole team which composes MEGABLOK, we want to thank all our customers, suppliers, sales people and workers for their support and confidence, received during all these years, and for their contribution to make this project possible

We hope to continue counting on your support to go on growing and developing products together; and to continue earning the same trust, which has made us to arrive where we are now.

Kind regards,

José Antonio Villaverde  
General Manager  
MEGABLOK, S.A.U.

Cher client,

J'ai le plaisir de me diriger vers vous, en cette occasion pour vous présenter notre nouveau catalogue.

Nous continuons à élargir notre gamme de solutions avec plus de dessins, produits et possibilités pour l'équipement de collectivités.

Au même temps, nous vous présentons notre nouveau site web avec de plus amples renseignements sur nos produits et notre société, qui rends plus facile les consultations et le travail du quotidien.

Toute l'équipe de MEGABLOK aimerions remercier a tous nos clients, fournisseurs, vendeurs et personnel le soutien et la confiance accordée pendant tous ces années et sa contribution à que ce projet soit possible.

Nous espérons pouvoir continuer avec votre soutien pour pouvoir continuer à grandir et a développer nos produits ensemble, et de continuer à mériter la même confiance qui nous a fait arriver jusqu'ou nous sommes maintenant.

Cordialement.

José Antonio Villaverde  
Gérant  
MEGABLOK, S.A.U.

Prezado cliente:

É com muito prazer que gostaríamos de lhe mostrar o nosso novo catálogo.

Continuamos ampliando a gama de soluções com mais projetos, produtos e possibilidades para o equipamento de coletivos.

Também, apresentamos o nosso novo site com informação ampliada de nossos produtos e empresa, o qual vai acelerar as consultas e o trabalho diário.

Em nome próprio e no de toda a equipe que formamos MEGABLOK queremos agradecer a todos nossos clientes, fornecedores, vendedores e trabalhadores pelo apoio e a confiança recebida durante todos estes anos e vossa contribuição para que este projeto fosse possível.

Esperamos continuar tendo seu apoio para crescer ainda mais, desenvolver produtos juntos; e continuar merecendo a mesma confiança que nos fez chegar até aqui.

Cordiais saudações

José Antonio Villaverde  
Gerente  
MEGABLOK, S.A.U.



# MEGABLOK®

**AIOMME**  
LABORATORIO DE ENSAYOS Y PRODUCTOS

**CERTIFICADO DE ENSAYO nº 231.X.1805.257.ES.03**  
*Atestación: 180322-00-0*

**PRODUCTO:** TABUILLA METÁLICA SERIE MODULAR

**EMPRESA:** MEGABLOK, S. A.U. PLATAFORMA LOGÍSTICA PLAZA, C/ PALERMO 7 50197 ZARAGOZA (ESPAÑA) Tlfno: 976.54.54.88 CIF: A.50711488

**ENSAJO:** Adecuación a las siguientes normas de especificaciones: "UNE EN 1621-2014-A1:2017" Mobiliario de almacenamiento de uso no doméstico. Requisitos de seguridad, resistencia, durabilidad y estabilidad. Nivel 2. Uso Severo.

**RESULTADO:** Cumple satisfactoriamente las especificaciones fijadas por la norma en los siguientes ensayos aplicables al modelo:

ENSAJOS	RESULTADO
Apdo. 5 Requisitos generales de seguridad:	CORRECTO
Apdo. 5.2 Requisitos generales de seguridad:	CORRECTO
Apdo. 5.3 Puntos de sujeción y procesamiento:	CORRECTO
Apdo. 5.6 Estabilidad:	ESTABLE
Apdo. 5.7 Seguridad estructural:	CORRECTO
Apdo. 5.7.1.2 Ensayo de retención del entrepaño: Fuerza horizontal (F <sub>h</sub> > 50 N, n= 1 vez)	CORRECTO
Apdo. 5.7.1.3 Ensayo de retención del entrepaño: Fuerza vertical (F <sub>v</sub> > 200 N, n= 1 vez)	CORRECTO
Apdo. 5.7.1.4 Resistencia de las zapatas del entrepaño (Q <sub>a</sub> : 10 kg, M <sub>a</sub> : 1.7 kg, n= 10 veces)	CORRECTO
Apdo. 5.7.1.5 Carga vertical de las puertas giratorias (M <sub>a</sub> : 20 kg, n= 10 veces)	CORRECTO
Apdo. 5.7.1.6 Carga horizontal de las puertas giratorias (F <sub>h</sub> : 80 N, n= 10 veces)	CORRECTO
Apdo.6. Resistencia y durabilidad:	CORRECTO
Apdo. 6.1.1 Resistencia de las zapatas de las barras para roca (Q <sub>a</sub> : 4.0 kg/cm, L: 1 hora)	CORRECTO
Apdo. 6.1.2 Resistencia de las perlas para la roca (Q <sub>a</sub> : 100N, n= 10 ciclos)	CORRECTO
Apdo. 6.1.3 Durabilidad de las perlas para la roca (M <sub>a</sub> : 2.0 kg, n= 80.000 ciclos)	CORRECTO
Apdo. 6.1.4 Ensayo de cama trazo de las puertas giratorias (M <sub>a</sub> : 1.7 kg, n= 10 veces)	CORRECTO
Apdo. 6.1.14 Ensayo de caída (H = 50 mm)	CORRECTO
Apdo. 6.1.15 Fricción de las entrepaños (Q <sub>a</sub> : 2.0kg/cm <sup>2</sup> kg, 7 días)	CORRECTO
Apdo. 6.1.16 Desprendimiento de las barras para la roca (Q <sub>a</sub> : 5 kg/cm, L: 7 días)	CORRECTO

Palerna, 01 de Junio de 2018

*AIOMME*  
Fco. José María Naranjo  
Responsable Laboratorio de Muebles y Productos

El presente certificado únicamente concierne a las muestras enviadas por el Laboratorio de AIOMME.  
Los resultados publicados en este informe de ensayo se refieren únicamente al número de ensayo N° 231.X.1805.257.ES.03 30/05/2018.  
AIOMME es miembro de ANEP/ENFEDOC, el Pacto Europeo de Innovación para la Industria Forestal de la Madeira y el Alentejo, entre otros, y es miembro de AIOMME/ENFEDOC, el Pacto Europeo de Innovación para la Industria Forestal de la Madeira y el Alentejo, entre otros. AIOMME es miembro de AIOMME/ENFEDOC, el Pacto Europeo de Innovación para la Industria Forestal de la Madeira y el Alentejo, entre otros. AIOMME es miembro de AIOMME/ENFEDOC, el Pacto Europeo de Innovación para la Industria Forestal de la Madeira y el Alentejo, entre otros.  
AIOMME, INSTITUTO TECNOLÓGICO METALÚRGICO, S.L. ARZOBISPADO DE TOLEDO, 60. 01007 PATERNA (CT), ESPAÑA. Teléfono: 976 54 54 88. E-mail: aiomme@aiomme.com  
Paterna (España) - Calle Arzobispado Toledo, 60. C/P. Entrecorredor 4º-4ºB. Edificio Corredor España. Tel. 976 54 54 88. Fax: 976 54 82 81. [www.aiomme.com](http://www.aiomme.com)

**AIOMME**  
LABORATORIO DE ENSAYOS Y PRODUCTOS

**CERTIFICADO DE ENSAYO nº 231.X.1805.258.ES.03**  
*Atestación: 180322-00-0*

**PRODUCTO:** TABUILLA METÁLICA SERIE MONOBLOK

**EMPRESA:** MEGABLOK, S. A.U. PLATAFORMA LOGÍSTICA PLAZA, C/ PALERMO 7 50197 ZARAGOZA (ESPAÑA) Tlfno: 976.54.54.88 CIF: A.50711488

**ENSAJO:** Adecuación a las siguientes normas de especificaciones: "UNE EN 1621-2014-A1:2017" Mobiliario de almacenamiento de uso no doméstico. Requisitos de seguridad, resistencia, durabilidad y estabilidad. Nivel 2. Uso Severo.

**RESULTADO:** Cumple satisfactoriamente las especificaciones fijadas por la norma en los siguientes ensayos aplicables al modelo:

ENSAJOS	RESULTADO
Apdo. 5 Requisitos generales de seguridad:	CORRECTO
Apdo. 5.2 Requisitos generales de seguridad:	CORRECTO
Apdo. 5.3 Puntos de sujeción y procesamiento:	CORRECTO
Apdo. 5.6 Estabilidad:	ESTABLE
Apdo. 5.7 Seguridad estructural:	CORRECTO
Apdo. 5.7.1.2 Ensayo de retención del entrepaño: Fuerza horizontal (F <sub>h</sub> > 50 N, n= 1 vez)	CORRECTO
Apdo. 5.7.1.3 Ensayo de retención del entrepaño: Fuerza vertical (F <sub>v</sub> > 200 N, n= 1 vez)	CORRECTO
Apdo. 5.7.1.4 Resistencia de las zapatas del entrepaño (Q <sub>a</sub> : 10 kg, M <sub>a</sub> : 1.7 kg, n= 10 veces)	CORRECTO
Apdo. 5.7.1.5 Carga vertical de las puertas giratorias (M <sub>a</sub> : 20 kg, n= 10 veces)	CORRECTO
Apdo. 5.7.1.6 Carga horizontal de las puertas giratorias (F <sub>h</sub> : 80 N, n= 10 veces)	CORRECTO
Apdo. 5.7.1.10 Muestras que desprecian en el suelo (F <sub>o</sub> < 200 N)	CORRECTO
Apdo.6. Resistencia y durabilidad:	CORRECTO
Apdo. 6.1.1 Resistencia de las zapatas de las barras para roca (Q <sub>a</sub> : 4.0 kg/cm, L: 1 hora)	CORRECTO
Apdo. 6.1.2 Resistencia de las perlas para la roca (Q <sub>a</sub> : 100N, n= 10 ciclos)	CORRECTO
Apdo. 6.1.3 Durabilidad de las puertas giratorias (M <sub>a</sub> : 2.0 kg, n= 80.000 ciclos)	CORRECTO
Apdo. 6.1.4 Ensayo de cama trazo de las puertas giratorias (M <sub>a</sub> : 1.7 kg, n= 10 veces)	CORRECTO
Apdo. 6.1.15 Fricción de las entrepaños (Q <sub>a</sub> : 2.0kg/cm <sup>2</sup> kg, 7 días)	CORRECTO
Apdo. 6.1.16 Desprendimiento de las barras para la roca (Q <sub>a</sub> : 5 kg/cm, L: 7 días)	CORRECTO

Palerna, 01 de Junio de 2018

*AIOMME*  
Fco. José María Naranjo  
Responsable Laboratorio de Muebles y Productos

El presente certificado únicamente concierne a las muestras enviadas por el Laboratorio de AIOMME.  
Los resultados publicados en este informe de ensayo se refieren únicamente al número de ensayo N° 231.X.1805.258.ES.03 del 01/05/2018.  
AIOMME es miembro de ANEP/ENFEDOC, el Pacto Europeo de Innovación para la Industria Forestal de la Madeira y el Alentejo, entre otros, y es miembro de AIOMME/ENFEDOC, el Pacto Europeo de Innovación para la Industria Forestal de la Madeira y el Alentejo, entre otros. AIOMME es miembro de AIOMME/ENFEDOC, el Pacto Europeo de Innovación para la Industria Forestal de la Madeira y el Alentejo, entre otros. AIOMME es miembro de AIOMME/ENFEDOC, el Pacto Europeo de Innovación para la Industria Forestal de la Madeira y el Alentejo, entre otros.  
AIOMME, INSTITUTO TECNOLÓGICO METALÚRGICO, S.L. ARZOBISPADO DE TOLEDO, 60. 01007 PATERNA (CT), ESPAÑA. Teléfono: 976 54 54 88. E-mail: aiomme@aiomme.com  
Paterna (España) - Calle Arzobispado Toledo, 60. C/P. Entrecorredor 4º-4ºB. Edificio Corredor España. Tel. 976 54 54 88. Fax: 976 54 82 81. [www.aiomme.com](http://www.aiomme.com)







**NOVEDAD**  
NEW  
NOVEUTÉ  
NOVIDADE



Pg. 99



Pg. 32



Pg. 33



Pg. 72



Pg. 75



Pg. 80

**NOVEDAD**  
NEW  
NOVEUTÉ  
NOVIDADE



Pg. 140



Pg. 182



Pg. 169



Pg. 190



Pg. 189



# AMBIENTE SECO

DRY ENVIRONMENT  
ENVIRONNEMENT SEC  
AMBIENTE SECO

# AMBIENTE HÚMEDO

WET ENVIRONMENT  
ENVIRONNEMENT HUMIDE  
AMBIENTE ÚMIDO



**Taquillas ECO**  
ECO lockers  
Vestiaires ECO  
Armários de vestiário ECO  
pag. 10 - 19



**Taquillas modulares**  
Disassembled lockers  
Vestiaires demontables  
Armários de vestiário desmontáveis  
pag. 20 - 35



**Serie GYM**  
GYM series  
Série GYM  
Série GYM  
pag. 30



**Serie CHASIS**  
CHASIS series  
Série CHASIS  
Série CHASIS  
pag. 31



**Taquillas monoblok**  
Monobloc lockers  
Vestiaires monobloc  
Cacifos monoblok  
pag. 36 - 49



**Taquillas multipuerta**  
Multidoor lockers  
Casiers visitables  
Cacifos multiportas  
pag. 50 - 53

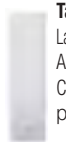

**Taquilla Lavandería**  
Laundry bulk collector locker  
Armoire a linge  
Cacifo lavandería  
pag. 64



**Taquilla Material Limpieza**  
Cleaning material locker  
Armoire pour materiel  
Armario de limpieza  
pag. 65



**Taquillas para oficinas**  
Office lockers  
Cabinets de bureau  
Cacifos para escritorio  
pág. 68-73



**ARC-4C**  
ARC-4C  
ARC-4C  
ARC-4C  
pág. 74



**Archivador**  
Office cupboards  
Armoires de bureau et atelier  
Armários de escritorio  
pag.75



**Armario metálico de persiana PVC**  
Metal cabinet with PVC rolling door  
Armoire metallique a rideau PVC  
Armários de escritorio  
pag. 76 - 77



**Armario de oficina y taller**  
Office and industrial cupboard  
Armoires de bureau et atelier  
Armários de escritorio  
pag. 78 - 79



**Armario plegable**  
Folding  
Armoire de bureau pliable  
Armário de escritorio dobrável  
pág. 80



**Serie BANCO / Serie MINI**  
BANCO series / MINI series  
Série BANCO / Série MINI  
Série BANCO / Série MINI  
pag. 88 - 89



**Serie SUPERMERCADO**  
SUPERMERCADO series  
Série SUPERMERCADO  
Série SUPERMERCADO  
pag. 90 - 94



**Serie Golf / Serie maletas**  
Golf series / Suitcase series  
Série golf / Série valises  
Série golf / Série malas  
pag. 95



**Departamentos**  
Compartmens  
Casiers  
Cacifos  
pag. 96 - 101



**Taquillas en melamina**  
Lockers in melamine  
Vestiaires en mélamine  
Cacifos folheado a madeira de tola  
pag. 102 - 111



**Taquillas melamina hidrófuga**  
Hydrophobic melamine lockers  
Vestiaires en mélaminé hydrofuge  
Cacifos de melamina hidrófuga  
pag. 112 - 119



**Taquillas en compacmel plus**  
Compacmel plus lockers  
Vestiaires en compacmel plus  
Cacifos de compacmel plus  
pag. 120 - 127



**Bancos en acero**  
Steel bench seats  
Bancos en acceir  
Bancos em aço  
pag. 152



**Percheros y repisas**  
Hooks and racks  
Crochets  
Cabides  
pag. 152 - 166



**Bancos en madera y acero**  
Wooden and steel bench seats  
Bancos en bois et de l'acier  
Bancos em madeira e aço  
pag. 153 - 157



**Bancos en melamina**  
Bench in melamine  
Bancos en mélamine  
Bancos em melamina  
pag. 162



**Accesorios de Vestuario**  
Lockers accessories  
Accessoires pour vestiaires  
Mobiliário para o banheiro  
pag. 176 - 177



**Bancos en fenólico**  
Phenolic bench seats  
Bancos en stratifié massif  
Bancos em fórmica  
pag. 163 - 169

# AMBIENTE EXTREMADAMENTE HÚMEDO

EXTREMELY WET ENVIRONMENT  
ENVIRONNEMENT EXTRÊMEMENT HUMIDE  
AMBIENTE EXTREMAMENTE ÚMIDO

## ¿QUÉ PRODUCTO NECESITO?

- 1º TIPO DE AMBIENTE
- 2º TIPO DE PRODUCTO
- 3º ELEGIR PRODUCTO

## QUEL PRODUIT AI-JE BESOIN?

- 1º TYPE D'ENVIRONNEMENT
- 2º TYPE DE PRODUIT
- 3º CHOISIR LE PRODUIT

## WHAT PRODUCT DO I NEED?

- TYPE OF ENVIRONMENT
- TYPE OF PRODUCT
- CHOOSE THE PRODUCT

## QUAL PRODUTO EU PRECISO?

- 1º TIPO DE AMBIENTE
- 2º TIPO DE PRODUTO
- 3º ESCOLHA O PRODUTO

## TAQUILLAS MODULARES

DISASSEMBLED LOCKERS / VESTIAIRES DEMONTABLES / ARMÁRIOS DE VESTIÁRIO DESMONTÁVEIS

1



**Taquillas INOX**  
INOX lockers  
Vestiaires INOX  
Armários de Vestiário INOX  
pag. 54 - 57

## TAQUILLAS MONOBLOK

MONOBLOC LOCKERS / VESTIAIRES MONOBLOC / CACIFOS MONOBLOK

2

## ARMARIOS DE OFICINA

OFFICE AND INDUSTRIAL CUPBOARDS / ARMOIRES DE BUREAU ET ATELIER / ARMÁRIOS DE ESCRITORIO

3

## CONSIGNAS

LEFT-LUGGAGE LOCKERS / CONSIGNES / CACIFOS

4



**Taquillas fenólicas**  
Phenolic lockers  
Vestiaires en stratifié  
CACIFOS de resinas fenólicas  
pag. 128 - 135



**Taquillas Fenólicas con Perfilera**  
Phenolic lockers with aluminium profile  
Vestiaires en stratifié avec profils  
CACIFOS de resinas fenólicas com perfilera de alumínio  
pag. 136 - 143



**Cabinas fenólicas**  
Phenolic cabins  
Cabines phénoliques  
Cabinas fenólicas  
pag. 144 - 147

## TAQUILLAS MELAMINA / TAQUILLAS FENÓLICAS / CABINAS FENÓLICAS

LOCKERS IN MELAMINE / VESTIAIRES EN MÉLAMINE / CACIFOS FOLHEADO A MADEIRA DE TOLA

5



**Bancos en PVC**  
PVC bench seats  
Bancos en PVC  
Bancos em PVC  
pag. 158 - 161



**Bancos en fenólico diseño**  
Phenolic bench seats design  
Bancos en stratifié massif conception  
Bancos em fórmica projeto  
pag. 167



**Mesas y bancos de comedor**  
Tables and benches for dining rooms  
Des tables et des bancs pour salle à manger  
Mesas e bancos para sala  
pag. 172 - 173

## BANCOS DE VESTUARIO / ACCESORIOS DE VESTUARIO

BENCH SEATS / BANCOS POUR VESTIAIRES / BANCOS DE VESTIÁRIO  
CHANGING ROOM ACCESSORIES / ACCESSORIES POUR VESTIAIRES / MOBILIÁRIO PARA O BANHEIRO

6



**Taquillas de plástico**  
Plastic lockers  
Vestiaires en plastique  
Armários em plástico  
pag. 178 - 183



**Suelos**  
Floors  
Sols  
Chãos  
pag. 184 - 185



**Armarios en resina de polipropileno**  
Polypropylene resin cupboards  
Armoires en resine de polypropilene  
Armários em resina de polipropileno  
pag. 186 - 187

## TAQUILLAS DE PLÁSTICO / SUELOS / CERRADURAS

PLASTIC LOCKERS / VESTIAIRES EN PLÁSTIQUE / ARMÁRIOS EM PLÁSTICO

7



**Taquillas ECO**  
ECO lockers  
Vestiaires ECO  
Armários de vestiário ECO  
pag. 10 - 19



**Taquillas modulares**  
Disassembled lockers  
Vestiaires demontables  
Armários de vestiário desmontáveis  
pag. 20 - 35



**Serie GYM**  
GYM series  
Série GYM  
Série GYM  
pag. 30



**Serie CHASIS**  
CHASIS series  
Série CHASIS  
Série CHASIS  
pag. 31



**Taquillas monoblok**  
Monobloc lockers  
Vestiaires monobloc  
Cacifos monobloc  
pag. 36 - 49



**Taquillas multipuerta**  
Multidoor lockers  
Casiers visitables  
Cacifos multiportas  
pag. 50 - 53



**Taquillas INOX**  
INOX lockers  
Vestiaires INOX  
Armários de Vestiário INOX  
pag. 54 - 57



**Taquilla Lavandería**  
Laundry bulk collector locker  
Armoire a linge  
Cacifo lavanderia  
pag. 64



**Taquilla Material Limpieza**  
Cleaning material locker  
Armoire pour materiel  
Armario de limpieza  
pag. 65



**Taquillas SKI**  
SKY lockers  
Vestiaires à SKI  
Cacifos SKI  
pag. 66 - 67



**Taquillas para oficinas**  
Office lockers  
Cabinets de bureau  
Cacifos para escritorio  
pág. 68-73



**ARC-4C**  
ARC-4C  
ARC-4C  
ARC-4C  
pág. 74



**Archivador**  
Office cupboards  
Armoires de bureau et atelier  
Armários de escritorio  
pag. 75



**Armario metálico de persiana PVC**  
Metal cabinet with PVC rolling door  
Armoire metallique a rideau PVC  
Armários de escritorio  
pag. 76 - 77



**Armario de oficina y taller**  
Office and industrial cupboard  
Armoires de bureau et atelier  
Armários de escritorio  
pag. 78 - 79



**Armario plegable**  
Folding  
Armoire de bureau pliable  
Armário de escritorio dobrável  
pág. 80



**Serie BANCO / Serie MINI**  
BANCO series / MINI series  
Série BANCO / Série MINI  
Série BANCO / Série MINI  
pag. 88 - 89



**Serie SUPERMERCADO**  
SUPERMERCADO series  
Série SUPERMERCADO  
Série SUPERMERCADO  
pag. 90 - 94



**Serie Golf / Serie maletas**  
Golf series / Suitcase series  
Série golf / Série valises  
Série golf / Série malas  
pag. 95



**Departamentos**  
Compartment  
Casiers  
Cacifos  
pag. 96 - 101



**Taquillas en melamina**  
Lockers in melamine  
Vestiaires en mélamine  
Cacifos folheado a madeira de tola  
pag. 102 - 111



**Taquillas melamina hidrófuga**  
Hydrophobic melamine lockers  
Vestiaires en mélaminé hydrofuge  
Cacifos de melamina hidrófuga  
pag. 112 - 119



**Taquillas en compacmel plus**  
Compacmel plus lockers  
Vestiaires en compacmel plus  
Cacifos de compacmel plus  
pag. 120 - 127



**Taquillas fenólicas**  
Phenolic lockers  
Vestiaires en stratifié  
Cacifos de resinas fenólicas  
pag. 128 - 135



**Taquillas Fenólicas con Perfilera**  
Phenolic lockers with aluminium profile  
Vestiaires en stratifié avec profiles  
Cacifos de resinas fenólicas com perfilaria de alumínio  
pag. 136 - 143



**Cabinas fenólicas**  
Phenolic cabins  
Cabines phénoliques  
Cabines fenólicas  
pag. 144 - 147



**Bancos en acero**  
Steel bench seats  
Bancs en acéir  
Bancos em aço  
pag. 152



**Percheros y repisas**  
Hooks and racks  
Crochets  
Cabides  
pag. 152 - 166



**Bancos en madera y acero**  
Wooden and steel bench seats  
Bancs en bois et de l'acier  
Bancos em madeira e aço  
pag. 153 - 157



**Bancos en PVC**  
PVC bench seats  
Bancs en PVC  
Bancos em PVC  
pag. 158 - 161

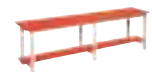

**Bancos en melamina**  
Bench in melamine  
Bancs en mélamine  
Bancos em melamina  
pag. 162



**Bancos en fenólico**  
Phenolic bench seats  
Bancs en stratifié massif  
Bancos em fórmica  
pag. 163 - 169



**Mesas y bancos de comedor**  
Tables and benches for dining rooms  
Des tables et des bancs pour salle à manger  
Mesas e bancos para sala  
pag. 172 - 173



**Accesorios de Vestuario**  
Lockers accessories  
Accessoires pour vestiaires  
Mobiliário para o banheiro  
pag. 176 - 177



**Taquillas de plástico**  
Plastic lockers  
Vestiaires en plástico  
Armários em plástico  
pag. 178 - 183



**Suelos**  
Floors  
Sols  
Chãos  
pag. 184 - 185



**Armarios en resina de polipropileno**  
Polypropylene resin cupboards  
Armoires en resine de polypropilene  
Armários em resina de polipropilene  
pag. 186 - 187



**Cerraduras**  
Locks  
Serrures  
Fechaduras  
pag. 188-189



**Taquillas Wifi**  
Wireless locker management  
Gestion de casiers moyennant Wifi  
Gestão de cacifos por Wifi  
pag. 190-191

## **TAQUILLAS MODULARES**

DISASSEMBLED LOCKERS / VESTIAIRES DEMONTABLES / ARMÁRIOS DE VESTIÁRIO DESMONTÁVEIS

## **TAQUILLAS MONOBLOK**

MONOBLOC LOCKERS / VESTIAIRES MONOBLOC / CACIFOS MONOBLOK

## **ARMARIOS DE OFICINA**

OFFICE AND INDUSTRIAL CUPBOARDS / ARMOIRES DE BUREAU ET ATELIER / ARMÁRIOS DE ESCRITORIO

## **CONSIGNAS**

LEFT-LUGGAGE LOCKERS / CONSIGNES / CACIFOS

## **TAQUILLAS MELAMINA / TAQUILLAS FENÓLICAS / CABINAS FENÓLICAS**

LOCKERS IN MELAMINE / VESTIAIRES EN MÉLAMINE / CACIFOS FOLHEADO A MADEIRA DE TOLA

## **BANCOS DE VESTUARIO / ACCESORIOS DE VESTUARIO**

BENCH SEATS / BANCS POUR VESTIAIRES / BANCOS DE VESTIÁRIO

CHANGING ROOM ACCESORIES / ACCESSORIES POUR VESTIAIRES / MOBILIÁRIO PARA O BANHEIRO

## **TAQUILLAS DE PLÁSTICO / SUELOS / CERRADURAS**

PLASTIC LOCKERS / VESTIAIRES EN PLÁSTIQUE / ARMÁRIOS EM PLÁSTICO





# TAQUILLAS ECO

ECO LOCKERS

VESTIAIRES ECO

ARMÁRIOS DE VESTIÁRIO ECO



## CARACTERÍSTICAS / CHARACTERISTICS / CARACTERISTIQUES / CARACTERISTICAS



Sistema inicial y de extensiones.  
Initial + adds system.  
Système de case départ plus cases suivantes.  
Sistema de cacifo inicial e sucesivos.



Fácil montaje.  
Easy assembly.  
Montage facile.  
Facil montagem.



No es recomendable para espacios húmedos.  
Not recommended for wet spaces.  
Pas recommandé pour les environnements humides.  
Nao é recomendável para lugares com humidade.



Trasera y bandejas galvanizada, no pintadas.  
Back panel and shelves are galvanized, not painted.  
Partie arrière et tablettes en acier galvanisé, non peint  
Parte de atrás e prateleiras construídas em aço galvanizado, não pintado.



Sin tornillos. (Mod. Modular)  
Without screws. (Mod. Dissassembled)  
Sans vis. (Mod. Demontables)  
Sem parafusos. (Mod. Desmontáveis)



Cerradura de llave.  
Standard key lock.  
Serrure standard à clé.  
Fechadura standard de chave.



Metal.  
Metal.  
Metal.  
Metal.



Pintado en Epoxi.  
Painted in Epoxy.  
Peinture en epoxi.  
Pintura em epoxi.



Con tornillos (Mod. ECO)  
With screws. (Mod. ECO)  
Avec vis. (Mod. ECO)  
Com parafusos. (Mod. ECO)



Microtexturado.  
Microtextured.  
Microtexturé.  
Microtexturado.



Gran resistencia.  
Great resistance.  
Très résistant.  
Muito resistente.



Etiquetero y rosetas de ventilación.  
Card holder and vent system.  
Porte-étiquette et volets d'aération.  
Placa de numeração e ventilação.



Cuerpo gris y puertas azul.  
Grey body and blue doors.  
Corp gris et portes bleu.  
Corpo cinza e portas azuis.

## OPCIONES / OPTIONS / OPTIONS / OPÇÕES

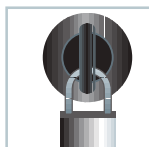

Pomo en poliamida  
(candado opcional)  
Padlockable Polyamide Lock  
(optional padlock)  
Poignée cadénassable en  
polyamide (cadenas en option)  
Fechadura de cadeado em  
poliamida



Pomo metálico (candado  
combinación opcional)  
Padlockable Metallic Lock  
(optional combination padlock)  
Poignée métallique (cadenas à  
combinación en option)  
Fechadura de cadeado em metal



Cerradura de combinación y  
llave de emergencia  
Lock of 4 manual digits with  
emergency key  
Serrure à combinaison et clef  
de émergence  
Fechadura de combinação e  
chave de emergência



Monedero (moneda retornable).  
Coin-operated Lock (coin-return).  
Monnayeur (monnaie réversible).  
Moedeiro (moeda retornável).

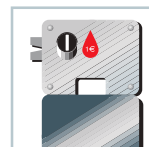

Monedero + cajetin depósito.  
Coin-operated Lock + Coin  
Collect Box (cash box, non  
coin-return).  
Monnayeur + tirelire (monnaie  
non réversible).  
Moedeiro + caixinha para as  
moedas.

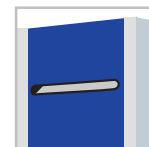

Ranura buzón. Puertas sin  
ventilación  
Mailbox Slot. Doors without  
vent system  
Rainure pour boîte à lettres.  
Portes sans volet d'aération  
Obertura para cartas. Portas  
sem ventilação



Patas regulables en PVC  
Adjustable PVC Legs  
Pieds réglables en PVC  
Pés reguláveis em altura  
em PVC



Patas en acero galvanizado  
Galvanized steel legs  
Pieds en acier galvanisé  
Pés em aço galvanizado

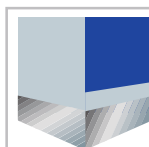

Zócalo inoxidable  
Stainless Steel Front Base  
and End Base  
Socle inoxydable  
Soclo inox



Atillo taquilla  
Upper small jointed locker  
Casier en réhausse  
Pequeno cacifo para pôr  
encima do armário de  
vestiário

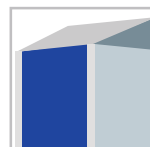

Sobreteto inclinado  
Slope Top  
Toit incliné  
Sobreteto com pequena  
inclinación

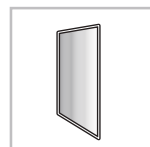

Espejo  
Mirror  
Miroir  
Espelho



Pulsera de nylon  
Bracelet of nylon  
Bracelet en nylon  
Pulseira de náilon



Pulsera elástica  
Elastic Bracelet  
Bracelet élastique  
Pulseira elástica

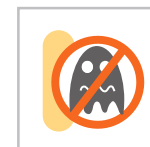

Pintura antibacteriana  
Antibacterial paint  
De la peinture  
antibactérienne  
Tinta antibacteriana

**COLORES OPCIONALES PUERTAS Y CUERPO**

OPTIONAL DOORS AND BODY COLOURS

COULEURS PORTES ET CORP OPTION

CORES DE PORTAS E CORPO OPCIONAIS

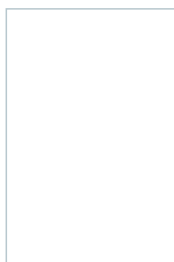

RAL 9010

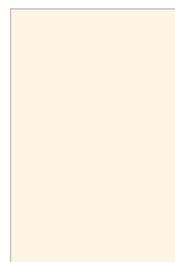

RAL 9001



RAL 1017



RAL 1021



RAL 2004



RAL 4010



RAL 3017



RAL 3000



RAL 3005



RAL 4005



RAL 6029



RAL 6034



RAL 5015



RAL 5023



RAL 5010



RAL 8025



RAL 7035



RAL 9006

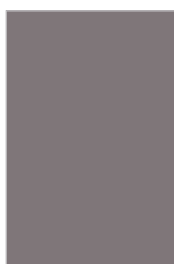

RAL 7036



RAL 7016



RAL 9005

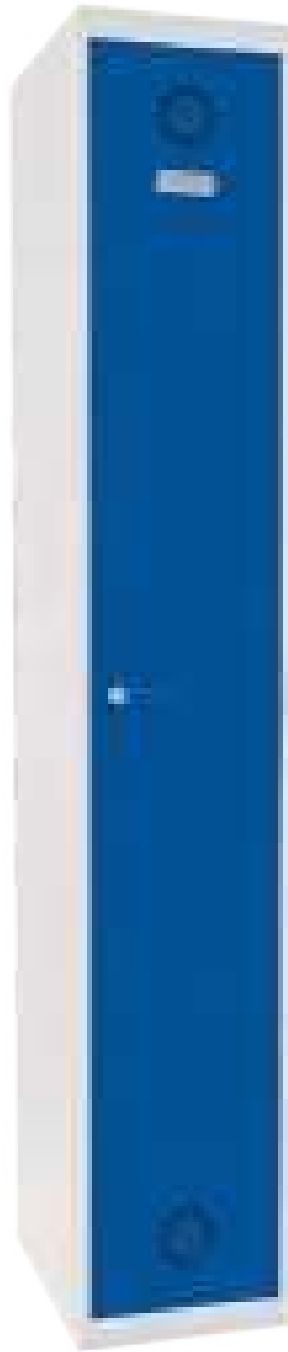

SERIE **ECOV**



SERIE **ECOT**



SERIE **ECOM**



SERIE **ECOC**



SERIE **ECOP**



SERIE **ECOB**



SERIE **ECOZ**



SERIE **ECOL**



SERIE ECOV



SERIE ECOT

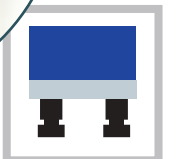



SERIE ECOT

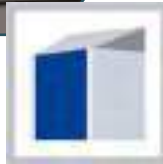

SERIE ECOV

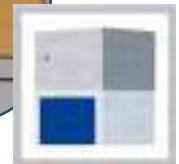
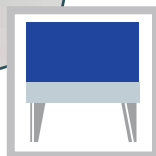
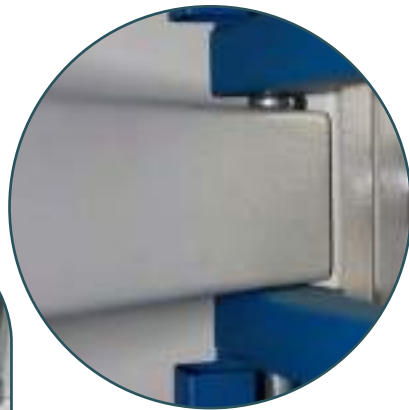

TAQUILLAS ECO / ECO LOCKERS / VESTIAIRES ECO / ARMÁRIOS DE VESTIÁRIO ECO

SERIE ECOV

ECOV-25/1 COD. 82501	ECOV-25/2 COD. 82502	ECOV-25/3 COD. 82503	ECOV-25/4 COD. 82504	ECOV-30/1 COD. 83001	ECOV-30/2 COD. 83002	ECOV-30/3 COD. 83003	ECOV-30/4 COD. 83004	ECOV-40/1 COD. 84001	ECOV-40/2 COD. 84002	ECOV-40/3 COD. 84003
16,7Kg. • 0,22m <sup>3</sup>	27,9Kg. • 0,45m <sup>3</sup>	39,1Kg. • 0,67m <sup>3</sup>	50,3Kg. • 0,9m <sup>3</sup>	19Kg. • 0,27m <sup>3</sup>	30,2Kg. • 0,54m <sup>3</sup>	46Kg. • 0,81m <sup>3</sup>	59,5Kg. • 1,08m <sup>3</sup>	20,3Kg. • 0,36m <sup>3</sup>	35,1Kg. • 0,72m <sup>3</sup>	49,9Kg. • 1,08m <sup>3</sup>

SERIE ECOT

ECOT-25/1 COD. 82511	ECOT-25/2 COD. 82512	ECOT-25/3 COD. 82513	ECOT-25/4 COD. 82514	ECOT-30/1 COD. 83011	ECOT-30/2 COD. 83012	ECOT-30/3 COD. 83013	ECOT-30/4 COD. 83014	ECOT-40/1 COD. 84011	ECOT-40/2 COD. 84012	ECOT-40/3 COD. 84013
18,4Kg. • 0,22m <sup>3</sup>	31,3Kg. • 0,45m <sup>3</sup>	44,2Kg. • 0,67m <sup>3</sup>	57,1Kg. • 0,9m <sup>3</sup>	19,1Kg. • 0,27m <sup>3</sup>	33,2Kg. • 0,54m <sup>3</sup>	47,3Kg. • 0,81m <sup>3</sup>	61,4Kg. • 1,08m <sup>3</sup>	23Kg. • 0,36m <sup>3</sup>	41Kg. • 0,72m <sup>3</sup>	59Kg. • 1,08m <sup>3</sup>

SERIE ECOM

ECOM-25/1 COD. 82531	ECOM-25/2 COD. 82532	ECOM-25/3 COD. 82533	ECOM-25/4 COD. 82534	ECOM-30/1 COD. 83031	ECOM-30/2 COD. 83032	ECOM-30/3 COD. 83033	ECOM-30/4 COD. 83034	ECOM-40/1 COD. 84031	ECOM-40/2 COD. 84032	ECOM-40/3 COD. 84033
19,9Kg. • 0,22m <sup>3</sup>	33,8Kg. • 0,45m <sup>3</sup>	47,7Kg. • 0,67m <sup>3</sup>	61,6Kg. • 0,9m <sup>3</sup>	21,2Kg. • 0,27m <sup>3</sup>	36,4Kg. • 0,54m <sup>3</sup>	51,6Kg. • 0,81m <sup>3</sup>	66,8Kg. • 1,08m <sup>3</sup>	24,2Kg. • 0,36m <sup>3</sup>	42,4Kg. • 0,72m <sup>3</sup>	60,6Kg. • 1,08m <sup>3</sup>

SERIE ECOC

ECOC-25/1 COD. 82521	ECOC-25/2 COD. 82522	ECOC-25/3 COD. 82523	ECOC-25/4 COD. 82524	ECOC-30/1 COD. 83021	ECOC-30/2 COD. 83022	ECOC-30/3 COD. 83023	ECOC-30/4 COD. 83024	ECOC-40/1 COD. 84021	ECOC-40/2 COD. 84022	ECOC-40/3 COD. 84023
20,8Kg. • 0,22m <sup>3</sup>	35,6Kg. • 0,45m <sup>3</sup>	50,4Kg. • 0,67m <sup>3</sup>	65,2Kg. • 0,9m <sup>3</sup>	22,3Kg. • 0,27m <sup>3</sup>	38,6Kg. • 0,54m <sup>3</sup>	54,9Kg. • 0,81m <sup>3</sup>	71,2Kg. • 1,08m <sup>3</sup>	25,7Kg. • 0,36m <sup>3</sup>	45,4Kg. • 0,72m <sup>3</sup>	65,1Kg. • 1,08m <sup>3</sup>

TAQUILLAS ECO / ECO LOCKERS / VESTIAIRES ECO / ARMÁRIOS DE VESTIÁRIO ECO

1

SERIE ECOP

ECOP-25/1 COD. 82621    ECOP-25/2 COD. 82622    ECOP-25/3 COD. 82623    ECOP-25/4 COD. 82624    ECOP-30/1 COD. 83621    ECOP-30/2 COD. 83062    ECOP-30/3 COD. 83063    ECOP-30/4 COD. 83064    ECOP-40/1 COD. 84061    ECOP-40/2 COD. 84062    ECOP-40/3 COD. 84063

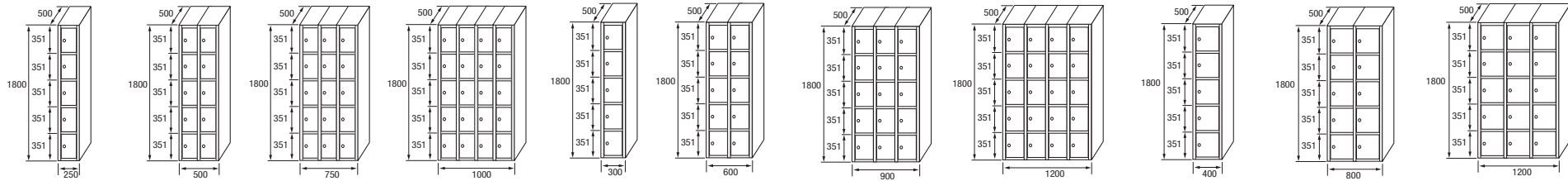

21,7Kg. • 0,22m<sup>3</sup>    38,4Kg. • 0,45m<sup>3</sup>    55,1Kg. • 0,67m<sup>3</sup>    71,8Kg. • 0,9m<sup>3</sup>    23,4Kg. • 0,27m<sup>3</sup>    40,9Kg. • 0,54m<sup>3</sup>    58,4Kg. • 0,81m<sup>3</sup>    75,9Kg. • 1,08m<sup>3</sup>    27,1Kg. • 0,36m<sup>3</sup>    48,30Kg. • 0,72m<sup>3</sup>    69,50Kg. • 1,08m<sup>3</sup>

SERIE ECOB

ECOB-25/1 COD. 82721    ECOB-25/2 COD. 82722    ECOB-25/3 COD. 82723    ECOB-25/4 COD. 82724    ECOB-30/1 COD. 83721    ECOB-30/2 COD. 83722    ECOB-30/3 COD. 83723    ECOB-30/4 COD. 83724    ECOB-40/1 COD. 84721    ECOB-40/2 COD. 84722    ECOB-40/3 COD. 84723

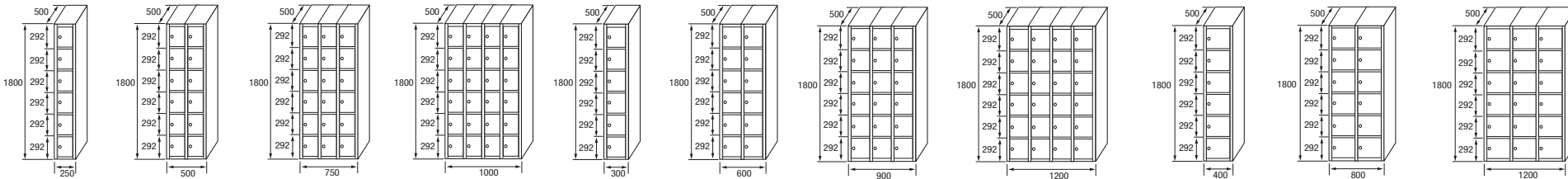

22,6Kg. • 0,22m<sup>3</sup>    40,2Kg. • 0,45m<sup>3</sup>    57,8Kg. • 0,67m<sup>3</sup>    75,4Kg. • 0,9m<sup>3</sup>    24,5Kg. • 0,27m<sup>3</sup>    44Kg. • 0,54m<sup>3</sup>    63,5Kg. • 0,81m<sup>3</sup>    83Kg. • 1,08m<sup>3</sup>    28,1Kg. • 0,36m<sup>3</sup>    51,2Kg. • 0,72m<sup>3</sup>    74,3Kg. • 1,08m<sup>3</sup>

SERIE ECOZ

ECOZ-25/1 COD. 82581    ECOZ-25/2 COD. 82582    ECOZ-25/3 COD. 82583    ECOZ-25/4 COD. 82584    ECOZ-30/1 COD. 83821    ECOZ-30/2 COD. 83822    ECOZ-30/3 COD. 83823    ECOZ-30/4 COD. 83824    ECOZ-40/1 COD. 84821    ECOZ-40/2 COD. 84822    ECOZ-40/3 COD. 84823

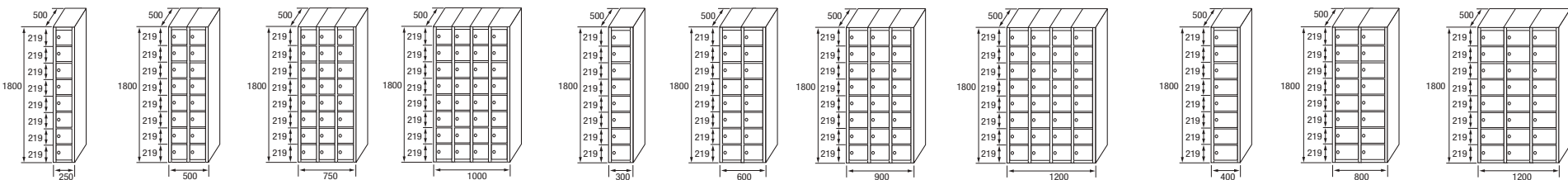

24,4Kg. • 0,22m<sup>3</sup>    43,8Kg. • 0,45m<sup>3</sup>    63,2Kg. • 0,67m<sup>3</sup>    82,6Kg. • 0,9m<sup>3</sup>    26,7Kg. • 0,27m<sup>3</sup>    48,4Kg. • 0,54m<sup>3</sup>    70,1Kg. • 0,81m<sup>3</sup>    91,8Kg. • 1,08m<sup>3</sup>    30,9Kg. • 0,36m<sup>3</sup>    56,8Kg. • 0,72m<sup>3</sup>    82,7Kg. • 1,08m<sup>3</sup>

SERIE ECOL

ECOL-30/1 COD. 35301    ECOL-30/2 COD. 35302    ECOL-30/3 COD. 35303    ECOL-30/4 COD. 35304    ECOL-40/1 COD. 35401    ECOL-40/2 COD. 35402    ECOL-40/3 COD. 35403

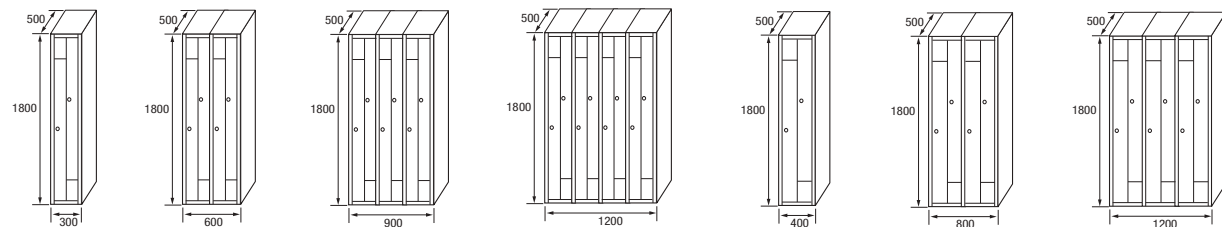

24,4Kg. • 0,27m<sup>3</sup>    42,9Kg. • 0,54m<sup>3</sup>    61,3Kg. • 0,81m<sup>3</sup>    79,8Kg. • 1,08m<sup>3</sup>    28,1Kg. • 0,36m<sup>3</sup>    50,2Kg. • 0,72m<sup>3</sup>    72,3Kg. • 1,08m<sup>3</sup>







# TAQUILLAS MODULARES

DISASSEMBLED LOCKERS

VESTIAIRES DEMONTABLES

ARMÁRIOS DE VESTIÁRIO DESMONTÁVEIS



SERIE AV



SERIE AT



SERIE AM



SERIE AC



SERIE AP



SERIE AB



SERIE AZ



AT-30



AV-30



AV-40

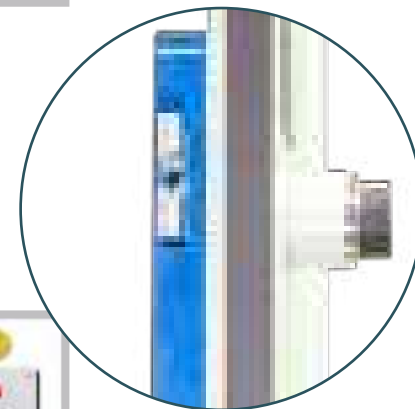



SERIE AT



SERIE AV

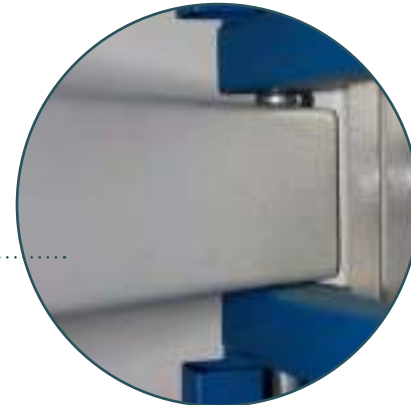
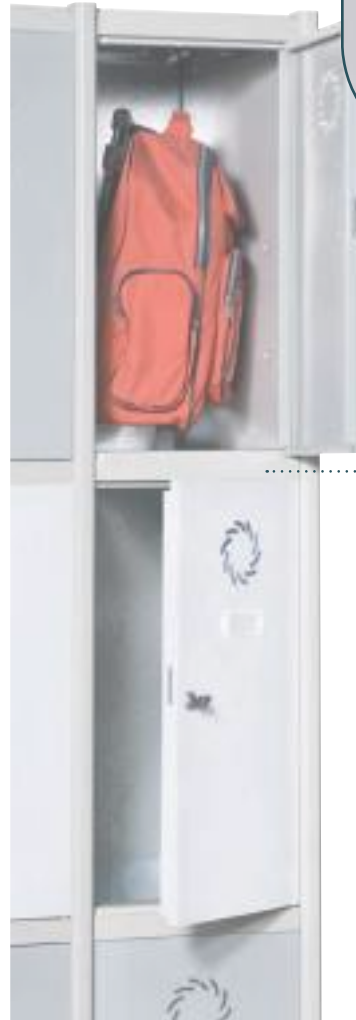

TAQUILLAS MODULARES / DISASSEMBLED LOCKERS / VESTIAIRES DEMONTABLES / ARMÁRIOS DE VESTIÁRIO DESMONTÁVEIS

SERIE AV

AV-25/1 COD. 32501	AV-25/2 COD. 32502	AV-25/3 COD. 32503	AV-25/4 COD. 32504	AV-30/1 COD. 33001	AV-30/2 COD. 33002	AV-30/3 COD. 33003	AV-30/4 COD. 33004
19,2Kg. • 0,26m <sup>3</sup>	32,4Kg. • 0,49m <sup>3</sup>	45,5Kg. • 0,72m <sup>3</sup>	58,7Kg. • 0,95m <sup>3</sup>	21,5Kg. • 0,30m <sup>3</sup>	37,0Kg. • 0,58m <sup>3</sup>	52,5Kg. • 0,85m <sup>3</sup>	68,0Kg. • 1,13m <sup>3</sup>

AV-35/1 COD. 33501	AV-35/2 COD. 33502	AV-35/3 COD. 33503	AV-40/1 COD. 34001	AV-40/2 COD. 34002	AV-40/3 COD. 34003	AV-45/1 COD. 34501	AV-45/2 COD. 34502
22,8Kg. • 0,35m <sup>3</sup>	39,6Kg. • 0,67m <sup>3</sup>	56,4Kg. • 0,99m <sup>3</sup>	26,5Kg. • 0,39m <sup>3</sup>	47,0Kg. • 0,76m <sup>3</sup>	67,5Kg. • 1,13m <sup>3</sup>	27,9Kg. • 0,44m <sup>3</sup>	49,8Kg. • 0,85m <sup>3</sup>

SERIE AT

AT-25/1 COD. 32511	AT-25/2 COD. 32512	AT-25/3 COD. 32513	AT-25/4 COD. 32514	AT-30/1 COD. 33011	AT-30/2 COD. 33012	AT-30/3 COD. 33013	AT-30/4 COD. 33014
19,9Kg. • 0,26m <sup>3</sup>	33,8Kg. • 0,49m <sup>3</sup>	47,7Kg. • 0,72m <sup>3</sup>	61,6Kg. • 0,95m <sup>3</sup>	21,1Kg. • 0,30m <sup>3</sup>	36,2Kg. • 0,58m <sup>3</sup>	51,3Kg. • 0,85m <sup>3</sup>	66,4Kg. • 1,13m <sup>3</sup>

AT-35/1 COD. 33511	AT-35/2 COD. 33512	AT-35/3 COD. 33513	AT-40/1 COD. 34011	AT-40/2 COD. 34012	AT-40/3 COD. 34013
22,7Kg. • 0,35m <sup>3</sup>	39,4Kg. • 0,67m <sup>3</sup>	56,1Kg. • 0,99m <sup>3</sup>	25,0Kg. • 0,39m <sup>3</sup>	44,0Kg. • 0,76m <sup>3</sup>	63,0Kg. • 1,13m <sup>3</sup>

SERIEAM

AM-25/1 COD. 32531 AM-25/2 COD. 32532 AM-25/3 COD. 32533 AM-25/4 COD. 32534 AM-30/1 COD. 33031 AM-30/2 COD. 33032 AM-30/3 COD. 33033 AM-30/4 COD. 33034

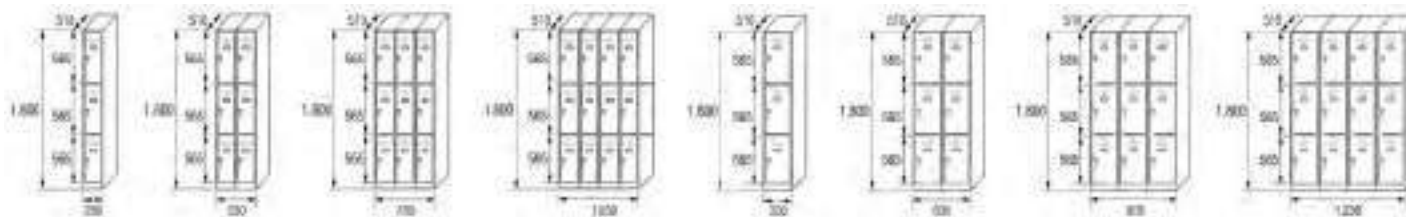

20,9Kg. • 0,26m³ 35,8Kg. • 0,49m³ 50,6Kg. • 0,72m³ 65,5Kg. • 0,95m³ 22,2Kg. • 0,30m³ 38,4Kg. • 0,58m³ 54,6Kg. • 0,85m³ 70,8Kg. • 1,13m³

AM-35/1 COD. 33531 AM-35/2 COD. 33532 AM-35/3 COD. 33533 AM-40/1 COD. 34031 AM-40/2 COD. 34032 AM-40/3 COD. 34033

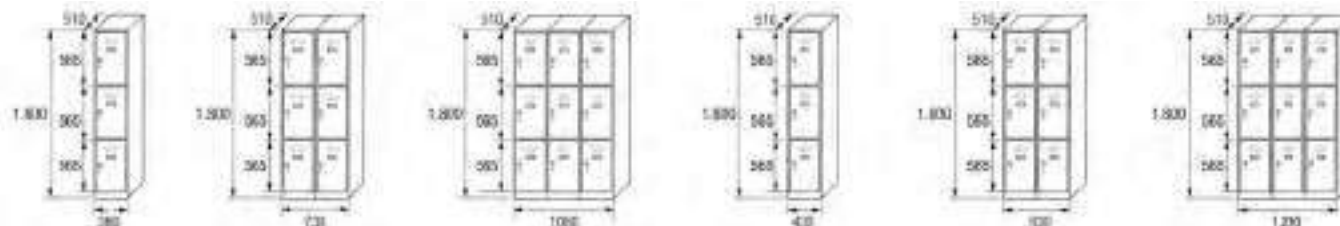

23,7Kg. • 0,35m³ 41,4Kg. • 0,67m³ 59,1Kg. • 0,99m³ 25,2Kg. • 0,39m³ 44,4Kg. • 0,76m³ 63,6Kg. • 1,13m³

AC-25/1 COD. 32521 AC-25/2 COD. 32522 AC-25/3 COD. 32523 AC-25/4 COD. 32524 AC-30/1 COD. 33021 AC-30/2 COD. 33022 AC-30/3 COD. 33023 AC-30/4 COD. 33024

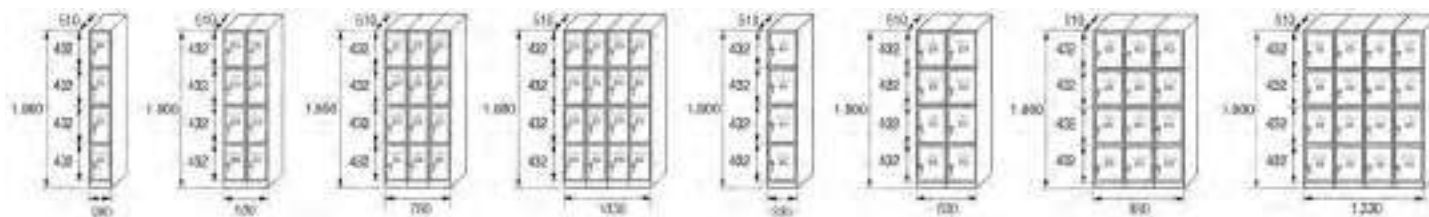

21,8g. • 0,26m³ 37,6Kg. • 0,49m³ 53,4Kg. • 0,72m³ 69,2Kg. • 0,95m³ 23,3Kg. • 0,30m³ 40,7Kg. • 0,58m³ 58,0Kg. • 0,85m³ 75,4Kg. • 1,13m³

AC-35/1 COD. 33521 AC-35/2 COD. 33522 AC-35/3 COD. 33523 AC-40/1 COD. 34021 AC-40/2 COD. 34022 AC-40/3 COD. 34023

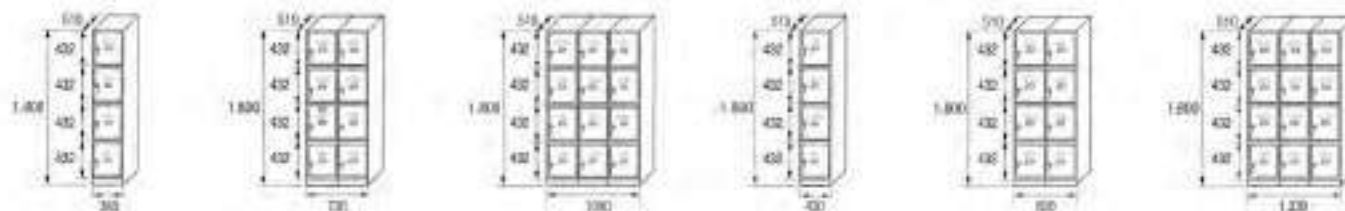

25,08Kg. • 0,35m³ 44,16Kg. • 0,67m³ 63,24Kg. • 0,99m³ 26,7Kg. • 0,39m³ 47,4Kg. • 0,76m³ 68,1Kg. • 1,13m³

SERIEAC

TAQUILLAS MODULARES / DISASSEMBLED LOCKERS / VESTIAIRES DEMONTABLES / ARMÁRIOS DE VESTIÁRIO DESMONTÁVEIS

SERIEAP

AP-25/1 COD. 32551	AP-25/2 COD. 32552	AP-25/3 COD. 32553	AP-25/4 COD. 32554	AP-30/1 COD. 33051	AP-30/2 COD. 33052	AP-30/3 COD. 33053	AP-30/4 COD. 33054	AP-40/1 COD. 34051	AP-40/2 COD. 34052	AP-40/3 COD. 34053
22,7Kg. • 0,26m <sup>3</sup>	39,4Kg. • 0,49m <sup>3</sup>	56,1Kg. • 0,72m <sup>3</sup>	72,8Kg. • 0,95m <sup>3</sup>	24,4Kg. • 0,30m <sup>3</sup>	42,9Kg. • 0,58m <sup>3</sup>	61,3Kg. • 0,85m <sup>3</sup>	79,8Kg. • 1,13m <sup>3</sup>	28,1Kg. • 0,39m <sup>3</sup>	50,2Kg. • 0,76m <sup>3</sup>	72,3Kg. • 1,13m <sup>3</sup>

SERIEAB

AB-25/1 COD. 32561	AB-25/2 COD. 32562	AB-25/3 COD. 32563	AB-25/4 COD. 32564	AB-30/1 COD. 33061	AB-30/2 COD. 33062	AB-30/3 COD. 33063	AB-30/4 COD. 33064	AB-40/1 COD. 34061	AB-40/2 COD. 34062	AB-40/3 COD. 34063
23,6Kg. • 0,26m <sup>3</sup>	41,2Kg. • 0,49m <sup>3</sup>	58,8Kg. • 0,72m <sup>3</sup>	76,4Kg. • 0,95m <sup>3</sup>	25,5Kg. • 0,30m <sup>3</sup>	45,1Kg. • 0,58m <sup>3</sup>	64,6Kg. • 0,85m <sup>3</sup>	84,2Kg. • 1,13m <sup>3</sup>	29,1Kg. • 0,39m <sup>3</sup>	51,2Kg. • 0,76m <sup>3</sup>	73,3Kg. • 1,13m <sup>3</sup>

SERIEAZ

AZ-25/1 COD. 32581	AZ-25/2 COD. 32582	AZ-25/3 COD. 32583	AZ-25/4 COD. 32584	AZ-30/1 COD. 33081	AZ-30/2 COD. 33082	AZ-30/3 COD. 33083	AZ-30/4 COD. 33084	AZ-40/1 COD. 34081	AZ-40/2 COD. 34082	AZ-40/3 COD. 34083
25,4Kg. • 0,26m <sup>3</sup>	44,8Kg. • 0,49m <sup>3</sup>	64,2Kg. • 0,72m <sup>3</sup>	83,6Kg. • 0,95m <sup>3</sup>	27,7Kg. • 0,30m <sup>3</sup>	49,5Kg. • 0,58m <sup>3</sup>	71,2Kg. • 0,85m <sup>3</sup>	93Kg. • 1,13m <sup>3</sup>	31,9Kg. • 0,39m <sup>3</sup>	56,8Kg. • 0,76m <sup>3</sup>	81,7Kg. • 1,13m <sup>3</sup>





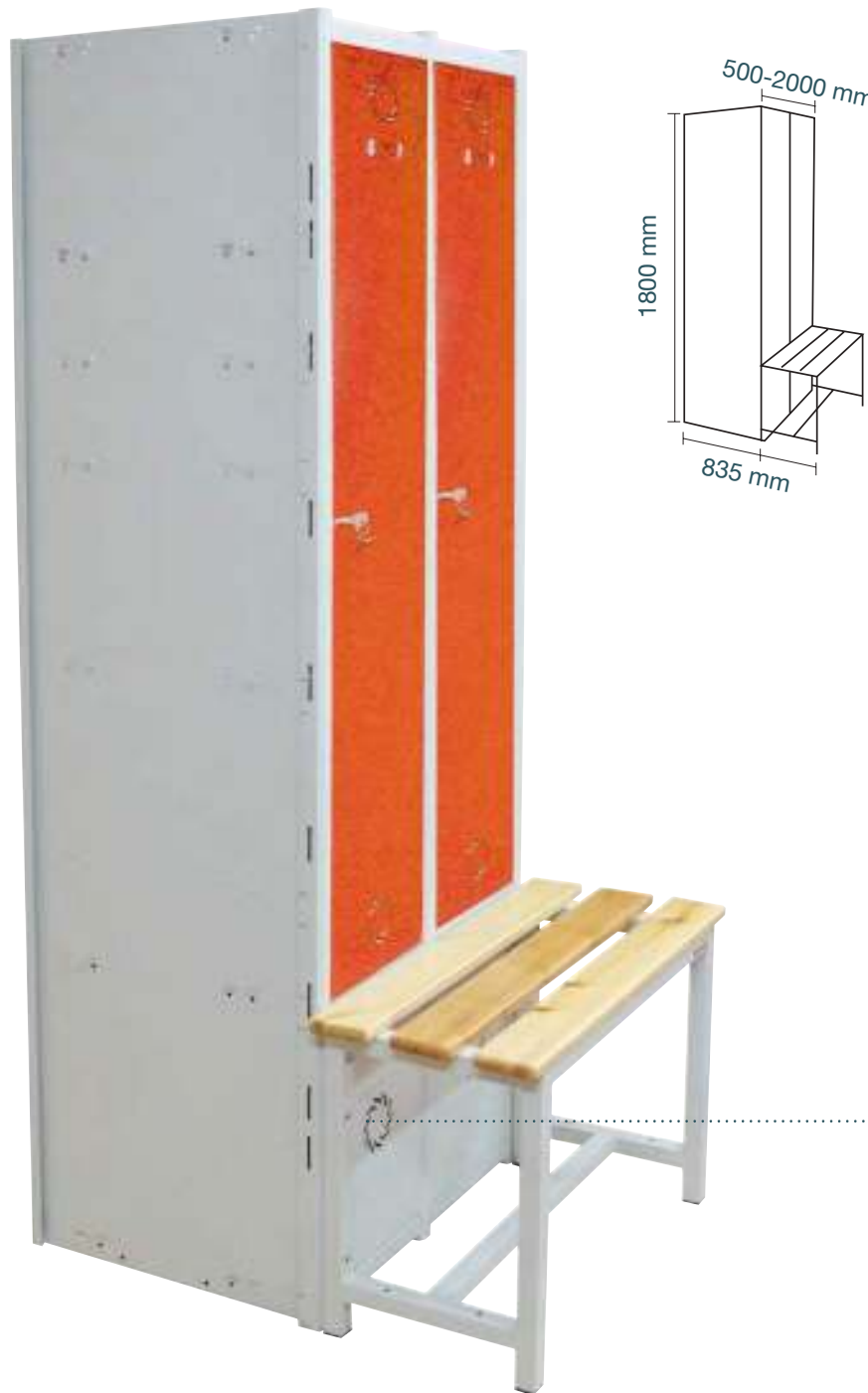

SERIE GYM

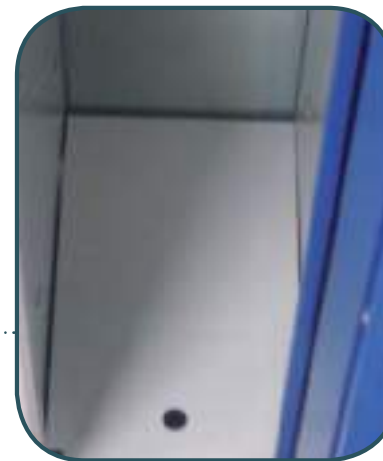

Doble fondo oculto  
Covered double floor  
Double fond occulte  
Fundo do cacifo oculto



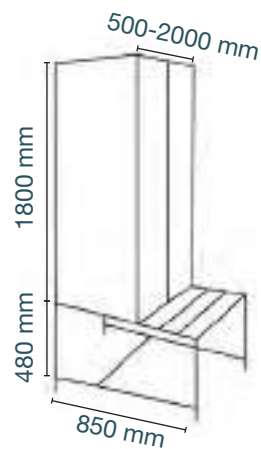

# SERIE CHASIS



Combina con taquillas ECO, MODULARES Y MONOBLOK.  
Combines with ECO, DISASSEMBLED AND MONOBLOK lockers.  
Combiné avec ECO, DEMONTABLES et vestiaires MONOBLOK.  
Combinado com armários ECO, DESMONTÁVEIS e vestiário MONOBLOK.

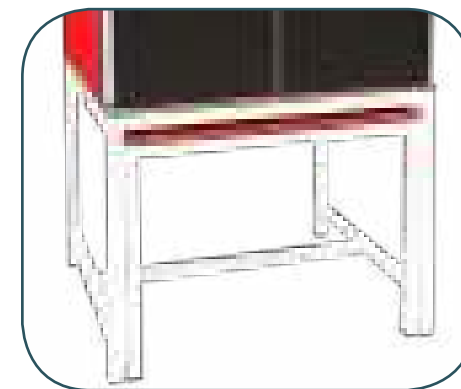

Opción: Banco retráctil  
Option: Retractable bench  
Option: banc rétractable  
Opção: Banco retrátil

CONSIGNAS BAJO BANCO / LOCKERS FOR BENCH SEATS / CONSIGNES POUR BANCS / CACIFOS PARA BANCOS



BANCO / BENCH / BANC / BANCO  
 1.000 - 1.500 - 2.000 mm.



Consigna doble puerta  
 Double door locker  
 Consigne double porte  
 Cacifo porta dupla



Lateral embellecedor  
 Decorative end panel  
 Enjoliveur lateral  
 Lateral de finição



BANCO / BENCH / BANC / BANCO  
 1.000 - 1.500 - 2.000 mm.



Consigna  
 Single door locker  
 Consigne une porte  
 Cacifo única porta

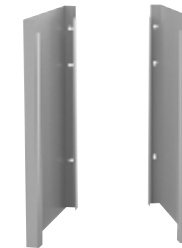

Lateral embellecedor  
 Decorative end panel  
 Enjoliveur lateral  
 Lateral de finição





SERIE CHASIS: 500-2.000 mm

=



## PERSONALIZACIÓN LUX

LUX CUSTOMIZATION

PERSONNALISATION LUX

LUX PERSONALIZAÇÃO



### Interior pintado

Painted inside

Intérieur peint

Pintado Interior



### Espejo

Mirror

Miroir

Esphelo



### Bandeja pintada y porta perchas de aluminio

Painted shelf and coat bar in aluminium

Étagère peinte et cintres en aluminium

Prateleira pintada e barra de alumínio



**Tirador y llave abisagrada**

Handle and hinged key  
Poignée et clé charnière  
Puxador e chave articulada



**Conteras de plástico**

Plastic caps  
Bouchons en plastique  
Tampões de plástico







# TAQUILLAS MONOBLOK

MONOBLOC LOCKERS

VESTIAIRES MONOBLOC

CACIFOS MONOBLOK

**CARACTERÍSTICAS / CHARACTERISTICS / CARACTERISTIQUES / CARACTERISTICAS**



Estructura soldada.  
Welded structure.  
Structure soudée.  
Estrutura soldada.



Sin montaje.  
Without assembly.  
Pas de montage.  
Sem montagem.



Microtexturado.  
Microtextured.  
Microtexturé.  
Microtexturado.



Pintado en Epoxi.  
Painted in Epoxy.  
Peinture en epoxi.  
Pintura em epoxi.



No es recomendable para espacios humedos.  
Not recommended for wet spaces.  
Pas recommandé pour les environnements humides.  
Nao é recomendável para lugares com humidade.



Cerradura de llave.  
Standard key lock.  
Serrure standard à clé.  
Fechadura standard de chave.



Cuerpo gris y puertas azul.  
Grey body and blue doors.  
Corp gris et portes bleu.  
Corpo cinza e portas azuis.



Gran resistencia.  
Great resistance.  
Très résistant.  
Muito resistente.



Etiquetero y rosetas de ventilación.  
Card holder and vent system.  
Porte-étiquette et volets d'aération.  
Placa de numeração e ventilação.



Metal.  
Metal.  
Metal.  
Metal.



Incluye patas.  
Includes legs.  
Pieds inclus.  
Com pés.

**OPCIONES / OPTIONS / OPTIONS / OPÇÕES**

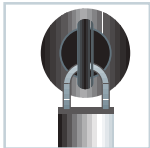

Pomo en poliamida  
(candado opcional)  
Padlockable Polyamide Lock  
(optional padlock)  
Poignée cadenassable en  
polyamide (cadenas en option)  
Fechadura de cadeado em poliamida



Pomo metálico (candado  
combinación opcional)  
Padlockable Metallic Lock  
(optional combination padlock)  
Poignée métallique (cadenas à  
combinaison en option)  
Fechadura de cadeado em metal



Cerradura de combinación y  
llave de emergencia  
Lock of 4 manual digits with  
emergency key  
Serrure à combinaison et clef  
de émergence  
Fechadura de combinação e  
chave de emergência



Monedero (moneda retornable).  
Coin-operated Lock (coin-return).  
Monnayeur (monnaie réversible).  
Moedeiro (moeda retornável).



Monedero + cajetin depósito.  
Coin-operated Lock + Coin Collect  
Box (cash box, non coin-return).  
Monnayeur + tirelire (monnaie  
non réversible).  
Moedeiro + caixinha para as  
moedas.



Cerradura electrónica de  
combinación de 4 dígitos.  
Electronic lock combination  
of 4 digits.  
Serrure électronique à  
combinaison de 4 chiffres.  
Fechadura electrónica,  
combinación de 4 dígitos.



Cerradura de proximidad  
Lock of proximity  
Serrure de proximité  
Fechadura de proximidade



Cerradura electrónica de  
combinación de 4 dígitos.  
Electronic lock combination  
of 4 digits.  
Serrure électronique à  
combinaison de 4 chiffres.  
Fechadura electrónica,  
combinación de 4 dígitos.



Cerradura electrónica de combinación  
de 4 dígitos.  
Electronic lock combination of 4 digits.  
Serrure électronique à combinaison  
de 4 chiffres.  
Fechadura electrónica, combinação  
de 4 dígitos.



Cerradura de proximidad  
Lock of proximity  
Serrure de proximité  
Fechadura de  
proximidade



Cerradura de proximidad  
Lock of proximity  
Serrure de proximité  
Fechadura de  
proximidade



Cerradura electrónica de combinación  
de 4 dígitos.  
Electronic lock combination of 4 digits.  
Serrure électronique à combinaison  
de 4 chiffres.  
Fechadura electrónica, combinação  
de 4 dígitos.



Cerradura electrónica de combinación  
de 4 dígitos.  
Electronic lock combination of 4 digits.  
Serrure électronique à combinaison  
de 4 chiffres.  
Fechadura electrónica, combinação  
de 4 dígitos.



Ranura buzón. Puertas sin ventilación  
Mailbox Slot. Doors without vent system  
Rainure pour boîte à lettres. Portes sans  
volet d'aération  
Obertura para cartas. Portas sem  
ventilação

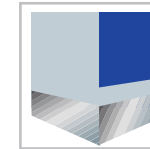

Zócalo inoxidable  
Stainless Steel Front Base  
and End Base  
Socle inoxydable  
Soclo inox



Altillo taquilla  
Upper small joined locker  
Casier en réhausse  
Pequeno cacifo para pôr encima  
do armário de vestiário

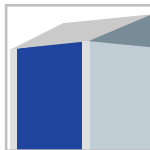

Sobretecho inclinado  
Slope Top  
Toit incliné  
Sobreteito com pequena  
inclinación

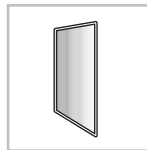

Especjo  
Mirror  
Miroir  
Espelho



Pulsera de nylon  
Bracelet of nylon  
Bracelet en nylon  
Pulseira de náilon



Pulsera elástica  
Elastic Bracelet  
Bracelet élastique  
Pulseira elástica

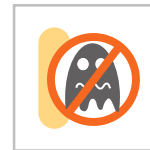

Pintura antibacteriana  
Antibacterial paint  
De la peinture  
antibactérienne  
Tinta antibacteriana



Cerradura de falleba  
Lock of shutter-bolt  
Serrure d'espagnolette  
Fechadura de espagnolette



Cerradura encastrable  
Lock encastrable  
Serrure encastrable  
Fechadura encastrable

## COLORES OPCIONALES PUERTAS Y CUERPO

OPTIONAL DOORS AND BODY COLOURS

COULEURS PORTES ET CORP OPTION

CORES DE PORTAS E CORPO OPCIONAIS

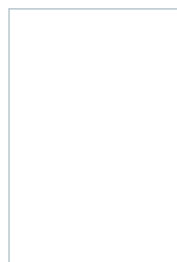

RAL 9010

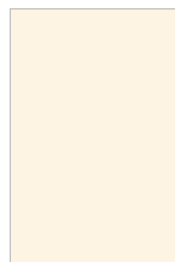

RAL 9001



RAL 1017



RAL 1021



RAL 2004



RAL 4010



RAL 3017



RAL 3000



RAL 3005



RAL 4005



RAL 6029



RAL 6034

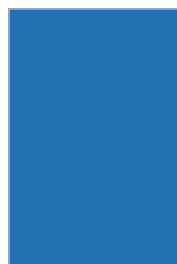

RAL 5015



RAL 5023



RAL 5010



RAL 8025



RAL 7035



RAL 9006

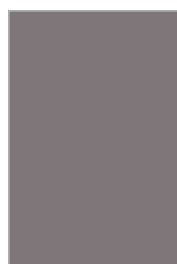

RAL 7036



RAL 7016



RAL 9005



SERIE SV



SERIE ST



SERIE SM



SERIE SC





SERIE SP



SERIE SB



SERIE SZ



SERIE SL2



SERIE SL4

SV-40



SV-30



ST-30



SL2

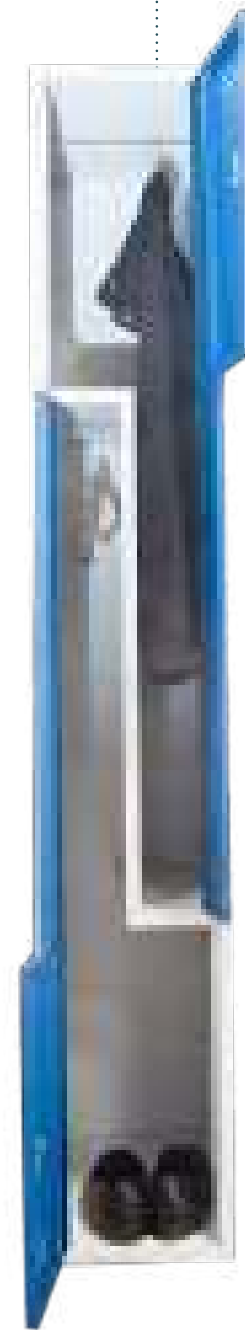

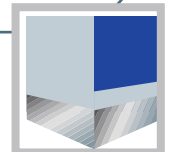
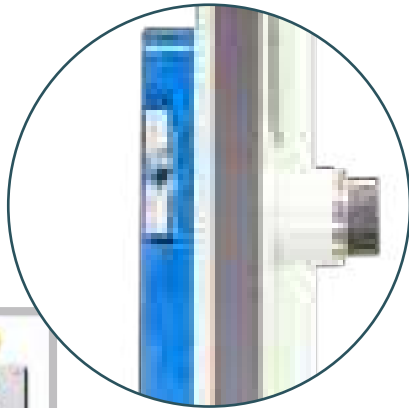
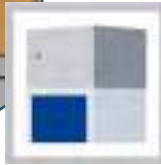

TAQUILLAS MONOBLOK / MONOBLOC LOCKERS / VESTIAIRES MONOBLOK / CACIFOS MONOBLOK

SERIE SV

SV-25/1 COD. 42501 SV-25/2 COD. 42502 SV-25/3 COD. 42503 SV-25/4 COD. 42504 SV-30/1 COD. 43001 SV-30/2 COD. 43002

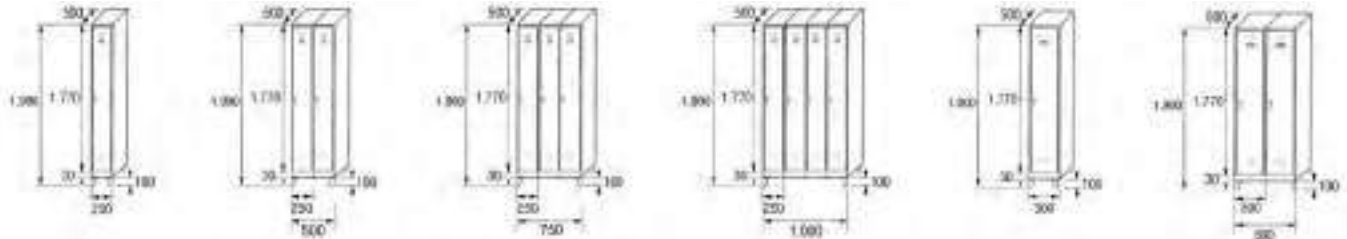

18,5Kg. • 0,24m<sup>3</sup> 31,0Kg. • 0,48m<sup>3</sup> 44,5Kg. • 0,71m<sup>3</sup> 57,0Kg. • 0,95m<sup>3</sup> 20,6Kg. • 0,29m<sup>3</sup> 35,2Kg. • 0,57m<sup>3</sup>

SV-30/3 COD. 43003 SV-30/4 COD. 43004 SV-40/1 COD. 44001 SV-40/2 COD. 44002 SV-40/3 COD. 44003 SV-50/1 COD. 45001 SV-50/2 COD. 45002

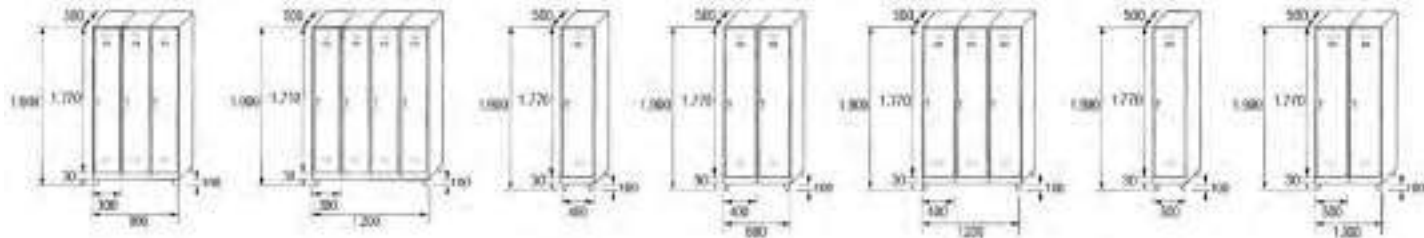

49,8Kg. • 0,86m<sup>3</sup> 64,4Kg. • 1,14m<sup>3</sup> 25,0Kg. • 0,38m<sup>3</sup> 45,0Kg. • 0,76m<sup>3</sup> 65,0Kg. • 1,14m<sup>3</sup> 28,0Kg. • 0,48m<sup>3</sup> 51,0Kg. • 0,95m<sup>3</sup>

ST-25/1 COD. 42511 ST-25/2 COD. 42512 ST-25/3 COD. 42513 ST-25/4 COD. 42514 ST-30/1 COD. 43011 ST-30/2 COD. 43012

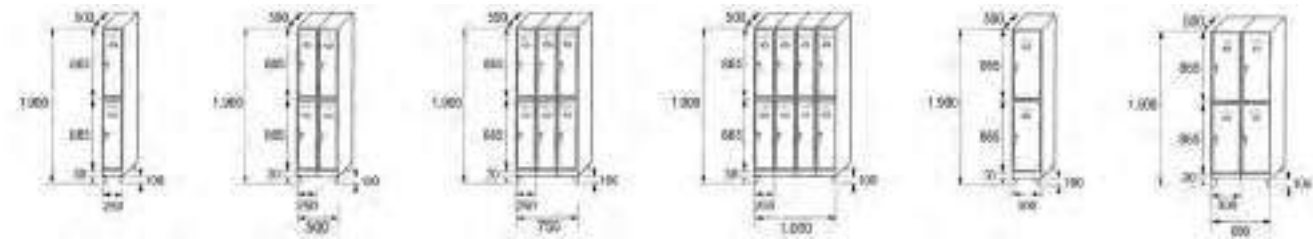

18,4Kg. • 0,24m<sup>3</sup> 30,8Kg. • 0,48m<sup>3</sup> 44,2Kg. • 0,71m<sup>3</sup> 56,6Kg. • 0,95m<sup>3</sup> 19,8Kg. • 0,29m<sup>3</sup> 33,6Kg. • 0,57m<sup>3</sup>

ST-30/3 COD. 43013 ST-30/4 COD. 43014 ST-40/1 COD. 44011 ST-40/2 COD. 44012 ST-40/3 COD. 44013 ST-50/1 COD. 45011 ST-50/2 COD. 45012

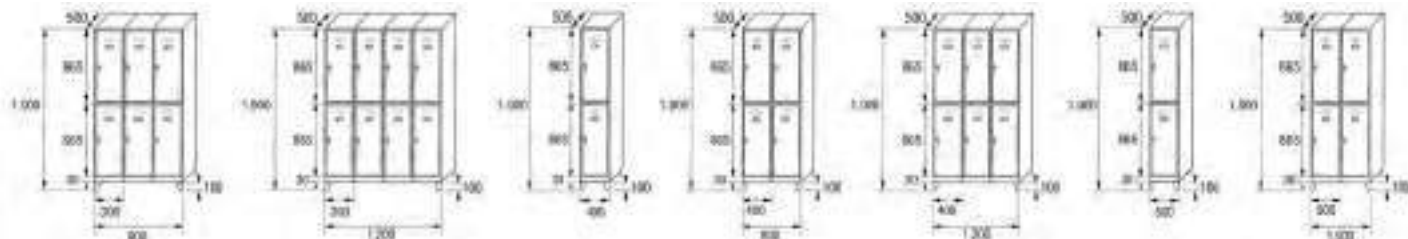

47,4Kg. • 0,86m<sup>3</sup> 62,2Kg. • 1,14m<sup>3</sup> 23,0Kg. • 0,38m<sup>3</sup> 41,0Kg. • 0,76m<sup>3</sup> 59,0Kg. • 1,14m<sup>3</sup> 26,0Kg. • 0,48m<sup>3</sup> 47,0Kg. • 0,95m<sup>3</sup>

SERIE ST

TAQUILLAS MONOBLOK / MONOBLOC LOCKERS / VESTIAIRES MONOBLOK / CACIFOS MONOBLOK

SERIE SM

SM-25/1  
COD. 42531

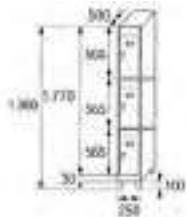

19,6Kg. • 0,24m<sup>3</sup>

SM-25/2  
COD. 42532

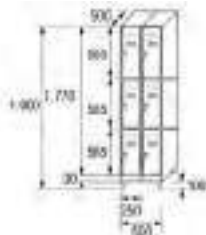

33,2Kg. • 0,48m<sup>3</sup>

SM-25/3  
COD. 42533



46,7Kg. • 0,71m<sup>3</sup>

SM-25/4  
COD. 42534



60,3Kg. • 0,95m<sup>3</sup>

SM-30/1  
COD. 43031



21,0Kg. • 0,29m<sup>3</sup>

SM-30/2  
COD. 43032

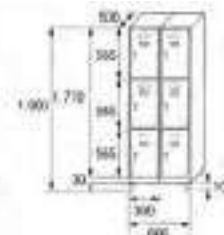

36,0Kg. • 0,57m<sup>3</sup>

SM-30/3  
COD. 43033



51,0Kg. • 0,86m<sup>3</sup>

SM-30/4  
COD. 43034

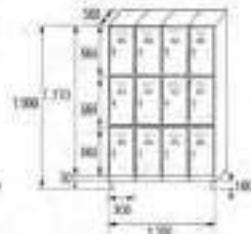

66,0Kg. • 1,14m<sup>3</sup>

SM-40/1  
COD. 44031

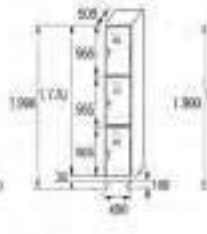

23,9Kg. • 0,38m<sup>3</sup>

SM-40/2  
COD. 44032



41,8Kg. • 0,76m<sup>3</sup>

SM-40/3  
COD. 44033

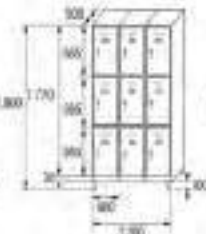

59,7Kg. • 1,14m<sup>3</sup>

SM-50/1  
COD. 45031

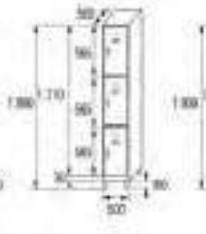

25,8Kg. • 0,48m<sup>3</sup>

SM-50/2  
COD. 45032



46,6Kg. • 0,95m<sup>3</sup>

SC-25/1  
COD. 42521

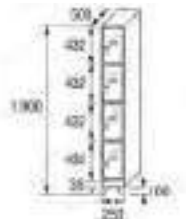

20,0Kg. • 0,24m<sup>3</sup>

SC-25/2  
COD. 42522

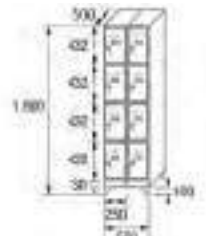

34,2Kg. • 0,48m<sup>3</sup>

SC-25/3  
COD. 42523



48,8Kg. • 0,71m<sup>3</sup>

SC-25/4  
COD. 42524

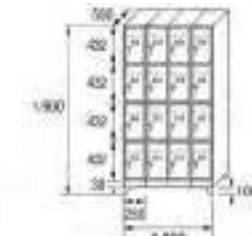

63,4Kg. • 0,95m<sup>3</sup>

SC-30/1  
COD. 43021

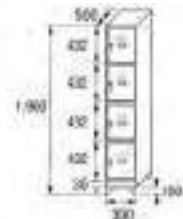

21,5Kg. • 0,29m<sup>3</sup>

SC-30/2  
COD. 43022

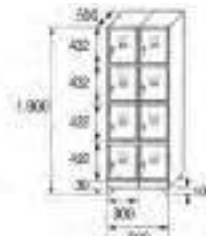

37,1Kg. • 0,57m<sup>3</sup>

SC-30/3  
COD. 43023

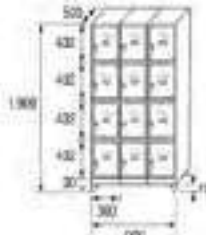

53,1Kg. • 0,86m<sup>3</sup>

SC-30/4  
COD. 43024

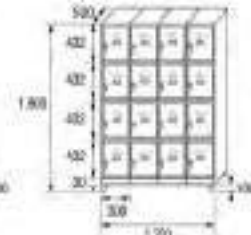

69,2Kg. • 1,14m<sup>3</sup>

SC-40/1  
COD. 44021



25,0Kg. • 0,38m<sup>3</sup>

SC-40/2  
COD. 44022



44,0Kg. • 0,76m<sup>3</sup>

SC-40/3  
COD. 44023

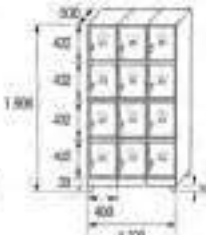

63,0Kg. • 1,14m<sup>3</sup>

SC-50/1  
COD. 45021



27,8Kg. • 0,48m<sup>3</sup>

SC-50/2  
COD. 45022



49,6Kg. • 0,95m<sup>3</sup>

SERIE SC

2



TAQUILLAS MONOBLOK / MONOBLOC LOCKERS / VESTIAIRES MONOBLOC / CACIFOS MONOBLOK

SERIESP

SP-25/1  
COD. 42551

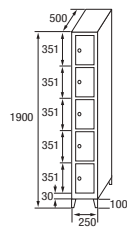

20,6Kg. • 0,24m<sup>3</sup>

SP-25/2  
COD. 42552

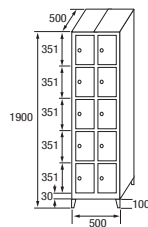

36,2Kg. • 0,48m<sup>3</sup>

SP-25/3  
COD. 42553

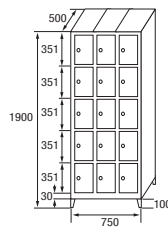

51,8Kg. • 0,71m<sup>3</sup>

SP-25/4  
COD. 42554

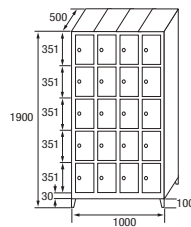

67,4Kg. • 0,95m<sup>3</sup>

SP-30/1  
COD. 43051

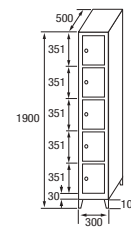

22,0Kg. • 0,29m<sup>3</sup>

SP-30/2  
COD. 43052

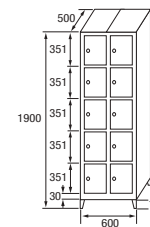

39,1Kg. • 0,57m<sup>3</sup>

SP-30/3  
COD. 43053

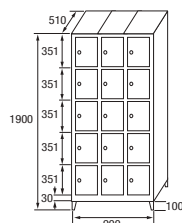

56,1Kg. • 0,86m<sup>3</sup>

SP-30/4  
COD. 43054

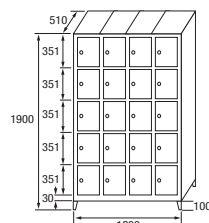

73,2Kg. • 1,14m<sup>3</sup>

SP-40/1  
COD. 44051

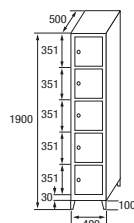

26,0Kg. • 0,38m<sup>3</sup>

SP-40/2  
COD. 44052

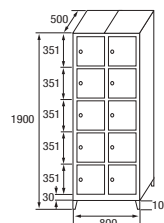

46,0Kg. • 0,76m<sup>3</sup>

SP-40/3  
COD. 44053

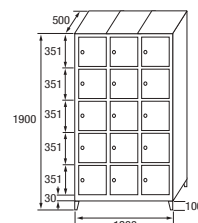

66,0Kg. • 1,14m<sup>3</sup>

SP-50/1  
COD. 45051

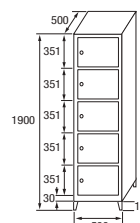

28,8Kg. • 0,48m<sup>3</sup>

SP-50/2  
COD. 45052

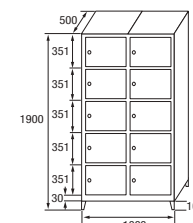

51,6Kg. • 0,95m<sup>3</sup>

SB-25/1  
COD. 42561

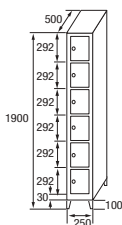

21,6Kg. • 0,24m<sup>3</sup>

SB-25/2  
COD. 42562

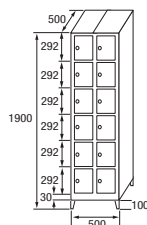

38,2Kg. • 0,48m<sup>3</sup>

SB-25/3  
COD. 42563

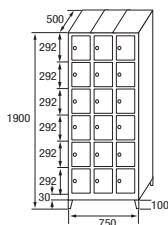

54,8Kg. • 0,71m<sup>3</sup>

SB-25/4  
COD. 42564

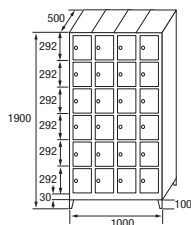

71,4Kg. • 0,95m<sup>3</sup>

SB-30/1  
COD. 43061

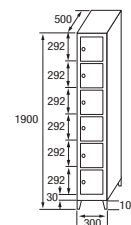

23,0Kg. • 0,29m<sup>3</sup>

SB-30/2  
COD. 43062

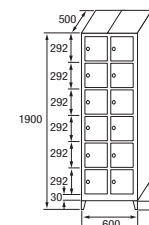

41,1Kg. • 0,57m<sup>3</sup>

SB-30/3  
COD. 43063

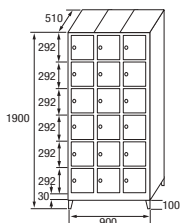

59,1Kg. • 0,86m<sup>3</sup>

SB-30/4  
COD. 43064

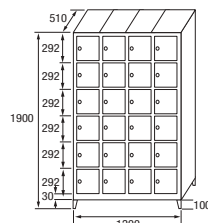

72,2Kg. • 1,14m<sup>3</sup>

SB-40/1  
COD. 44061

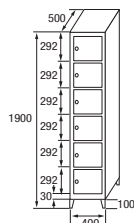

27,0Kg. • 0,38m<sup>3</sup>

SB-40/2  
COD. 44062

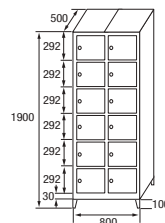

48,0Kg. • 0,76m<sup>3</sup>

SB-40/3  
COD. 44063

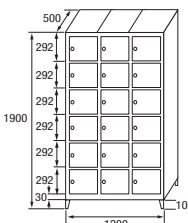

69,0Kg. • 1,14m<sup>3</sup>

SB-50/1  
COD. 45061

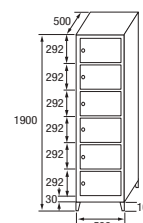

29,8Kg. • 0,48m<sup>3</sup>

SB-50/2  
COD. 45062

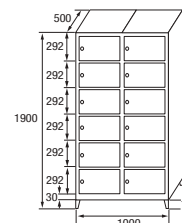

53,6Kg. • 0,95m<sup>3</sup>

SERIESB

TAQUILLAS MONOBLOK / MONOBLOC LOCKERS / VESTIAIRES MONOBLOC / CACIFOS MONOBLOK

SERIESZ

SZ-25/1  
COD. 42581

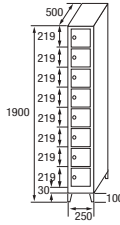

23,6Kg. • 0,24m<sup>3</sup>

SZ-25/2  
COD. 42582

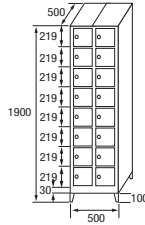

42,2Kg. • 0,48m<sup>3</sup>

SZ-25/3  
COD. 42583

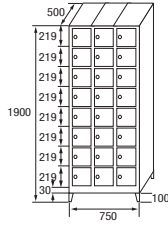

60,8Kg. • 0,71m<sup>3</sup>

SZ-25/4  
COD. 42584

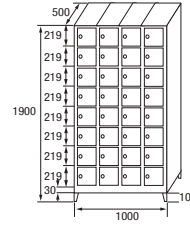

79,4Kg. • 0,95m<sup>3</sup>

SZ-30/1  
COD. 43081

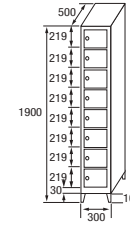

25,0Kg. • 0,29m<sup>3</sup>

SZ-30/2  
COD. 43082

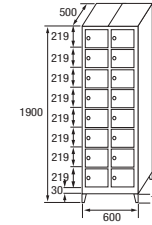

45,1Kg. • 0,57m<sup>3</sup>

SZ-30/3  
COD. 43083

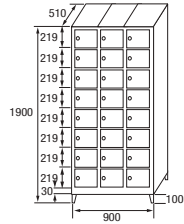

65,1Kg. • 0,86m<sup>3</sup>

SZ-30/4  
COD. 43084

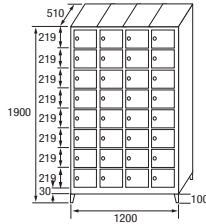

85,2Kg. • 1,14m<sup>3</sup>

SZ-40/1  
COD. 44081

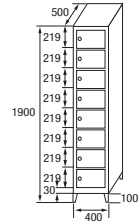

29,0Kg. • 0,38m<sup>3</sup>

SZ-40/2  
COD. 44082

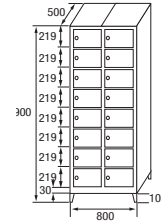

52,0Kg. • 0,76m<sup>3</sup>

SZ-40/3  
COD. 44083

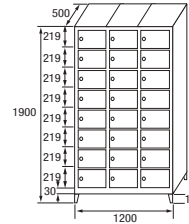

75,0Kg. • 1,14m<sup>3</sup>

SZ-50/1  
COD. 45081

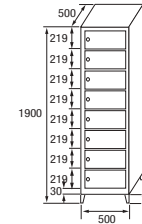

31,8Kg. • 0,48m<sup>3</sup>

SZ-50/2  
COD. 45082

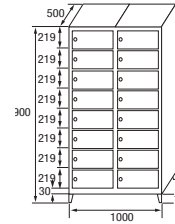

57,6Kg. • 0,95m<sup>3</sup>

SL2-30/1  
COD. 43041



21,0Kg. • 0,29m<sup>3</sup>

SL2-30/2  
COD. 43042

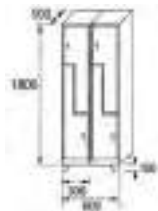

37,1Kg. • 0,57m<sup>3</sup>

SL2-30/3  
COD. 43043

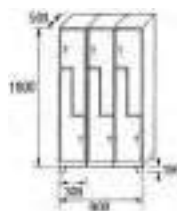

53,1Kg. • 0,86m<sup>3</sup>

SL2-30/4  
COD. 43143

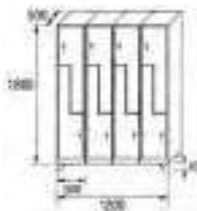

69,1Kg. • 1,14m<sup>3</sup>

SL2-40/1  
COD. 43044

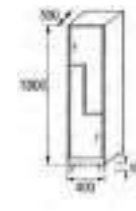

25,0Kg. • 0,38m<sup>3</sup>

SL2-40/2  
COD. 43045



44,0Kg. • 0,76m<sup>3</sup>

SL2-40/3  
COD. 43145

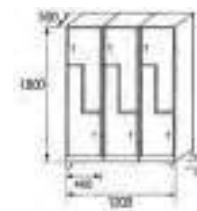

63,0Kg. • 1,14m<sup>3</sup>

SL4-30/1  
COD. 43051

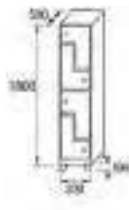

21,0Kg. • 0,29m<sup>3</sup>

SL4-30/2  
COD. 43052

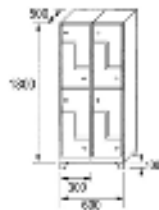

37,1Kg. • 0,57m<sup>3</sup>

SL4-30/3  
COD. 43053



53,1Kg. • 0,86m<sup>3</sup>

SL4-30/4  
COD. 43153

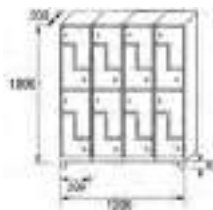

69,1Kg. • 1,14m<sup>3</sup>

SL4-40/1  
COD. 43054

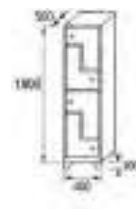

25,0Kg. • 0,38m<sup>3</sup>

SL4-40/2  
COD. 43055



44,0Kg. • 0,76m<sup>3</sup>

SL4-40/3  
COD. 43155



63,0Kg. • 1,14m<sup>3</sup>

SERIESL









SERIE STV2



SERIE STV3



SERIE STV4





SERIE STV5



SERIE STV6



SERIE STV8

TAQUILLAS MULTIPUERTAS / MULTIDOOR LOCKERS / CASIERS VISITABLES / CACIFOS MULTIPORTAS



SERIE STV2

STV2-40/1  
COD. 44821

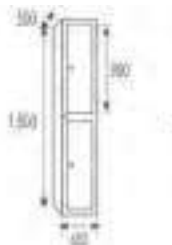

25,0Kg. • 0,29m<sup>3</sup>

STV2-40/2  
COD. 44822

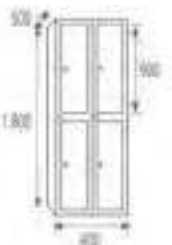

45,0Kg. • 0,57m<sup>3</sup>

STV2-40/3  
COD. 44823

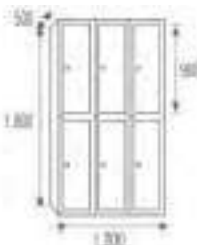

65,0Kg. • 1,08m<sup>3</sup>

SERIE STV3

STV3-40/1  
COD. 44831

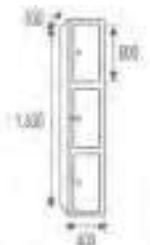

25,9Kg. • 0,29m<sup>3</sup>

STV3-40/2  
COD. 44832

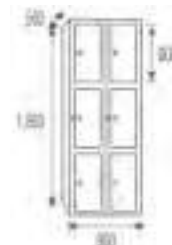

45,8Kg. • 0,57m<sup>3</sup>

STV3-40/3  
COD. 44833



65,7Kg. • 1,08m<sup>3</sup>

SERIE STV4

STV4-40/1  
COD. 44841

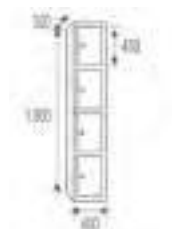

28,0Kg. • 0,29m<sup>3</sup>

STV4-40/2  
COD. 44842

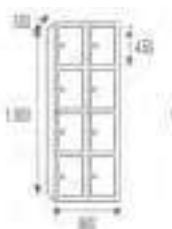

50,0Kg. • 0,57m<sup>3</sup>

STV4-40/3  
COD. 44843

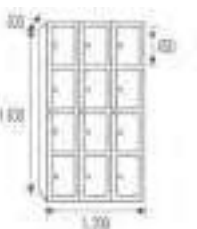

69,0Kg. • 1,08m<sup>3</sup>

SERIE STV5

STV5-40/1  
COD. 44851

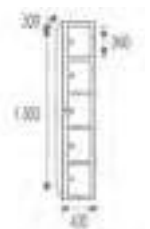

29,0Kg. • 0,29m<sup>3</sup>

STV5-40/2  
COD. 44852

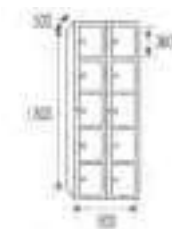

52,0Kg. • 0,57m<sup>3</sup>

STV5-40/3  
COD. 44853

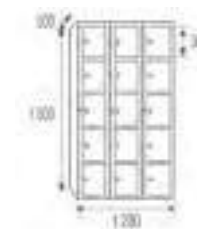

72,0Kg. • 1,08m<sup>3</sup>

SERIE STV6

STV6-40/1  
COD. 44861

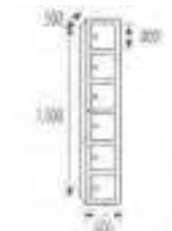

30,0Kg. • 0,29m<sup>3</sup>

STV6-40/2  
COD. 44862

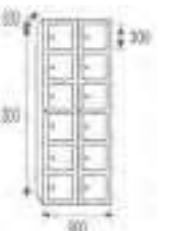

54,0Kg. • 0,57m<sup>3</sup>

STV6-40/3  
COD. 44863

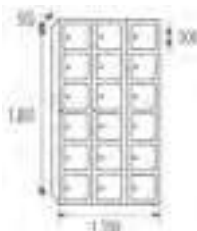

78,0Kg. • 1,08m<sup>3</sup>

SERIE STV8

STV8-40/1  
COD. 44881

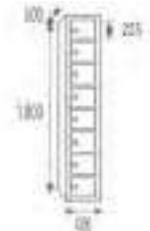

31,0Kg. • 0,29m<sup>3</sup>

STV8-40/2  
COD. 44882

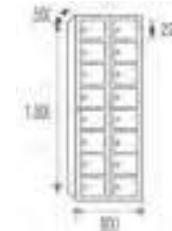

56,0Kg. • 0,57m<sup>3</sup>

STV8-40/3  
COD. 44883



81Kg. • 1,08m<sup>3</sup>

**CARACTERÍSTICAS / CHARACTERISTICS / CARACTERISTIQUES / CARACTERISTICAS**



Etiquetero y rosetas de ventilación.  
Card holder and vent system.  
Porte-étiquette et volets d'aération.  
Placa de numeração e ventilação.



Sin montaje.  
Without assembly.  
Pas de montage.  
Sem montagem.



Sobretecho inclinado  
Slope Top  
Toit incliné  
Sobreteito com pequena inclinação



Recomendado para ambientes húmedos. Resistente al agua. Waterproof.  
Recommended for wet areas. Waterproof.  
Recommandé pour les environnements humides.  
Recomendado para lugares com humidade. Resistente a água.



Cerradura de llave.  
Standard key lock.  
Serrure standard à clé.  
Fechadura standard de chave.



Inox.  
Stainless steel.  
Inox.  
Inox.



Puerta con refuerzo longitudinal.  
Door with longitudinal reinforcement.  
Porte avec renforcement longitudinal.  
Porta com reforço longitudinal.



Pata regulable en altura.  
Legs adjustable in height.  
Pieds réglables en hauteur.  
Pés reguláveis em altura.

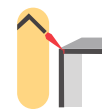

Estructura soldada.  
Welded structure.  
Structure soudée.  
Estrutura soldada.

**OPCIONES / OPTIONS / OPTIONS / OPÇÕES**

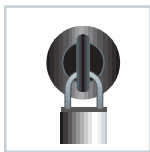

Pomo en poliamida  
(candado opcional)  
Padlockable Polyamide Lock  
(optional padlock)  
Poignée cadénassable en  
polyamide (cadenas en option)  
Fechadura de cadeado em poliamida



Pomo metálico (candado  
combinación opcional)  
Padlockable Metallic Lock  
(optional combination padlock)  
Poignée métallique (cadenas à  
combinación en option)  
Fechadura de cadeado em metal



Cerradura de combinación y  
llave de emergencia  
Lock of 4 manual digits with  
emergency key  
Serrure à combinaison et clef  
de émergence  
Fechadura de combinação e  
chave de emergência



Monedero (moneda retornable).  
Coin-operated Lock (coin-return).  
Monnayeur (monnaie réversible).  
Moedeiro (moeda retornável).

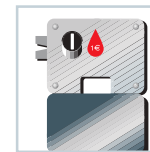

Monedero + cajetín depósito.  
Coin-operated Lock + Coin Collect  
Box (cash box, non coin-return).  
Monnayeur + tirelire (monnaie  
non réversible).  
Moedeiro + caixinha para as  
moedas.









SERIE SV

SV-25/1 Inox COD. 82901    SV-25/2 Inox COD. 82902    SV-25/3 Inox COD. 82903    SV-25/4 Inox COD. 82904

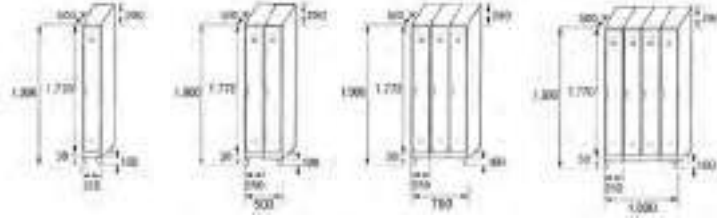

24,6Kg. • 0,24m<sup>3</sup>    40,3Kg. • 0,48m<sup>3</sup>    57,8Kg. • 0,71m<sup>3</sup>    74,10Kg. • 0,95m<sup>3</sup>

SERIE SV

SV-30/1 Inox COD. 83901    SV-30/2 Inox COD. 83902    SV-30/3 Inox COD. 83903    SV-30/4 Inox COD. 83904

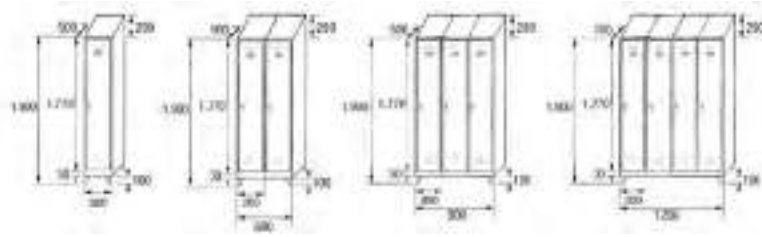

31,0Kg. • 0,38m<sup>3</sup>    49,0Kg. • 0,69m<sup>3</sup>    67,0Kg. • 0,99m<sup>3</sup>    85,0Kg. • 1,31m<sup>3</sup>

SERIE SV

SV-40/1 Inox COD. 84901    SV-40/2 Inox COD. 84902    SV-40/3 Inox COD. 84903



36,0Kg. • 0,38m<sup>3</sup>    59,0Kg. • 0,76m<sup>3</sup>    82,0Kg. • 1,14m<sup>3</sup>

SERIE ST

ST-25/1 Inox COD. 82911    ST-25/2 Inox COD. 82912    ST-25/3 Inox COD. 82913    ST-25/4 Inox COD. 82914

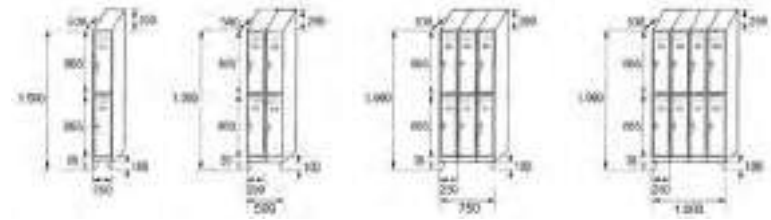

25,6Kg. • 0,24m<sup>3</sup>    41,3Kg. • 0,48m<sup>3</sup>    58,8Kg. • 0,71m<sup>3</sup>    75,1Kg. • 0,95m<sup>3</sup>

SERIE ST

ST-30/1 Inox COD. 83911    ST-30/2 Inox COD. 83912    ST-30/3 Inox COD. 83913    ST-30/4 Inox COD. 83914

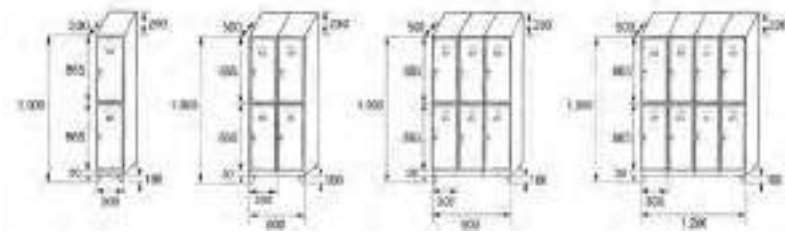

32,0Kg. • 0,69m<sup>3</sup>    50,0Kg. • 0,99m<sup>3</sup>    68,0Kg. • 0,99m<sup>3</sup>    86,0Kg. • 1,31m<sup>3</sup>

SERIE ST

ST-40/1 Inox COD. 84911    ST-40/2 Inox COD. 84912    ST-40/3 Inox COD. 84913

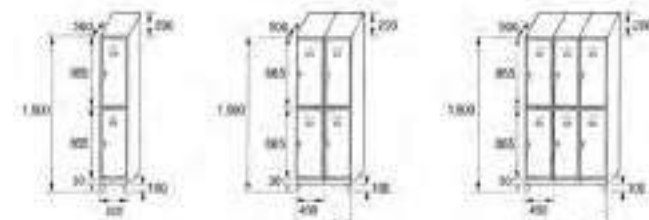

37,0Kg. • 0,38m<sup>3</sup>    60,0Kg. • 0,76m<sup>3</sup>    83,0Kg. • 1,14m<sup>3</sup>

## DISTRIBUCIONES INTERIORES

INTERNAL DISTRIBUTIONS

DISTRIBUTIONS INTERNES

DISTRIBUÇÕES INTERIORES

### **Cambio de sentido apertura de puertas**

Change of doors opening directions

Change de sens d'ouverture des portes

Possível mudar o lado de abertura das portas



## DIMENSIONES ESPECIALES

SPECIALS DIMENSIONS  
DIMENSIONS SPÉCIALES  
DIMENSÕES ESPECIAIS







## PUERTAS METÁLICAS CON ENREJILLADO

STEEL DOORS WITH MESH-GRILLE  
PORTES MÉTALLIQUES AVEC GRILLAGE  
PORTAS DE AÇO COM GRELHA



## CASILLERO INTERIOR

INTERNAL LOCKER  
CASIER INTERIEUR  
CACIFO INTERIOR



## POMO TIRADOR E IMÁN

KNOB-HANDLE AND MAGNET  
POIGNÉE ET L'AIMANT  
PUXADOR-IMÃ



## PUERTAS FENÓLICAS

HPL DOORS  
PORTES EN STRATIPIÉ  
PORTAS FENÓLICAS



## PUERTAS DE MELAMINA

MELAMINE DOORS  
PORTES EN MELAMINE  
PORTAS A MADERA DE TOLA



## PUERTAS DE METACRILATO

METHACRYLATE DOORS  
PORTES EN METHACRYLATE  
PORTAS METACRILATO



# TAQUILLA LAVANDERÍA

LAUNDRY BULK COLLECTOR LOCKER

ARMOIRE A LINGE

CACIFO LAVANDERIA



Sin montaje.  
Without assembly.  
Pas de montage.  
Sem montagem.



Cuerpo gris y puertas azul.  
Grey body and blue doors.  
Corp gris et portes bleu.  
Corpo cinza e portas azuis.



Estructura soldada.  
Welded structure.  
Structure soudée.  
Estrutura soldada.



Cerradura de llave.  
Standard key lock.  
Serrure standard à clé.  
Fechadura standard de chave.



Pintado en Epoxi.  
Painted in Epoxy.  
Peinture en epoxi.  
Pintura em epoxi.



Microtexturado.  
Microtextured.  
Microtexturé.  
Microtexturado.

MOD. TL-I  
COD. 42100

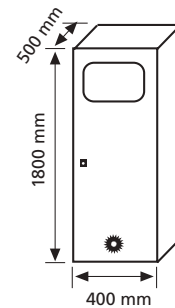



# ARMARIO MATERIAL DE LIMPIEZA

CLEANING MATERIAL LOCKER

ARMOIRE POUR MATERIEL DE NETTOYAGE

ARMARIO DE LIMPIEZA

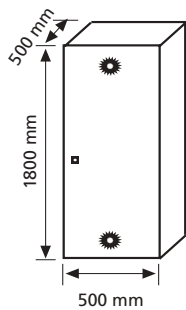

**MOD. AL-I**  
COD. 42000



Sin montaje.  
Without assembly.  
Pas de montage.  
Sem montagem.



Estructura soldada.  
Welded structure.  
Structure soudée.  
Estrutura soldada.



Pintado en Epoxi.  
Painted in Epoxy.  
Peinture en epoxi.  
Pintura em epoxi.



Color standard: Gris RAL 7035.  
Standard colour: Grey RAL 7035.  
Couleur standard: gris ral 7035.  
Cor standard: cinza ral 7035.



Barra portaperchas.  
Coat rod.  
Tringle porte cintres.  
Barra para pendurar cabides.



Metal.  
Metal.  
Metal.  
Metal.



Microtexturado.  
Microtextured.  
Microtexturé.  
Microtexturado.



## TAQUILLAS SKI

SKI LOCKER  
VESTIAIRES À SKI  
CACIFOS SKI



Estructura soldada.  
Welded structure.  
Structure soudée.  
Estrutura soldada.



Sin montaje.  
Without assembly.  
Pas de montage.  
Sem montagem.



Acero galvanizado.  
Galvanized sheet.  
Acier galvanisée.  
Aço galvanizado.



Cerradura de llave.  
Standard key lock.  
Serrure standard à clé.  
Fechadura standard de chave.



Color standard: Blanco RAL 9010.  
Standard colour: White RAL 9010.  
Couleur standard: Blanc RAL 9010.  
Cor standard: Branco RAL 9010.



Pintado en Epoxi.  
Painted in Epoxy.  
Peinture en epoxi.  
Pintura em epoxi.



Microtexturado.  
Microtextured.  
Microtexturé.  
Microtexturado.

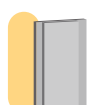

Puerta con refuerzo longitudinal.  
Door with longitudinal reinforcement.  
Porte avec renforcement longitudinal.  
Porta com reforço longitudinal.

SERIES	↑↓	□	↔	↗↘	kg	M <sup>3</sup>
SKI-1	2200	500	500		44,0	0,55
SKI-2	2200	300	500		31,0	0,33

OPCIÓN CALEFACTABLE  
OPTION CALEFACTABLE  
OPTION CHAUFFANTE  
OPÇÃO CALENTADOR



MOD. SKI-2  
COD. 42530

MOD. SKI-1  
COD. 42500



MOD. PS-3  
COD. 10901



MOD. PS-4C  
COD. 10950



MOD. PSB-4P  
COD. 10902



MOD. PS-1C  
COD. 10910



MOD. PSB-6P  
COD. 10930



MOD. SB-R  
COD. 10921

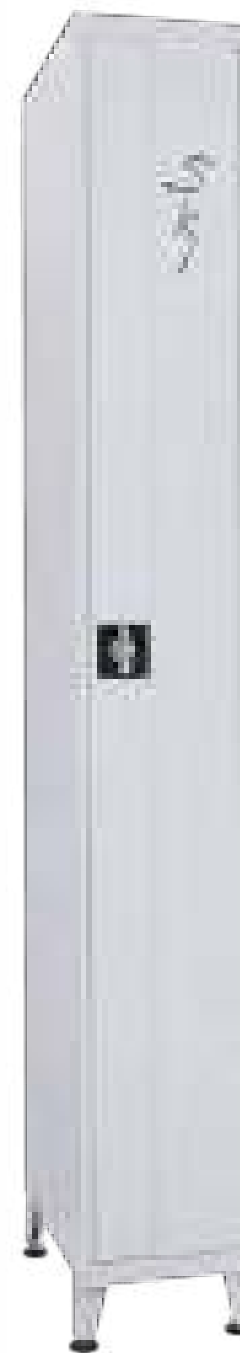





TAQUILLAS PARA OFICINAS  
OFFICE LOCKERS  
CABINETS DE BUREAU  
CACIFOS PARA ESCRITÓRIO

## OPEN SPACES

TAQUILLAS PARA OFICINAS

OFFICE LOCKERS

CABINETS DE BUREAU

CACIFOS PARA ESCRITÓRIO







## OPEN SPACES

TAQUILLAS PARA OFICINAS

OFFICE LOCKERS

CABINETS DE BUREAU

CACIFOS PARA ESCRITÓRIO





# ARCHIVADOR

OFFICE AND INDUSTRIAL CUPBOARDS  
 ARMOIRES DE BUREAU ET ATELIER  
 ARMÁRIOS DE ESCRITORIO

## CARACTERÍSTICAS TÉCNICAS

- Guías telescópicas de bolas, extracción total del cajón.
- Sistema antivuelco.
- Soporta 40 Kgs. por cajón.

## FEATURES

- Balls bearing runners, fully extending drawers.
- Anti tilt mechanism.
- Maximum drawer load of 40 kg.

## CARACTERISTIQUES TECHNIQUES

- Coulisses à billes, extraction totale du tiroir.
- Système anti-basculement.
- Chaque tiroir peut supporter 40 kg.

## CARACTERÍSTICAS TÉCNICAS

- Guías telescópicas de bolas, a gaveta abre na totalidade.
- Quando a gaveta abre, ela fica firme, não cae para fora.
- Soporta 40 kg cada gaveta.



MOD. ARC-4C



Estructura soldada.  
 Welded structure.  
 Structure soudée.  
 Estrutura soldada.



Sin montaje.  
 Without assembly.  
 Pas de montage.  
 Sem montagem.



Gran resistencia.  
 Great resistance.  
 Très résistant.  
 Muito resistente.



Cerradura de llave.  
 Standard key lock.  
 Serrure standard à clé.  
 Fechadura standard de chave.



Color standard: Gris RAL 7035.  
 Standard colour: Grey RAL 7035.  
 Couleur standard: gris ral 7035.  
 Cor standard: cinza ral 7035.



Pintado en Epoxi.  
 Painted in Epoxy.  
 Peinture en epoxi.  
 Pintura em epoxi.



Microtexturado.  
 Microtextured.  
 Microtexturé.  
 Microtexturado.

COLORES OPCIONALES  
 OPTIONAL COLOURS  
 COULEURS EN OPTION  
 CORES OPCIONAIS

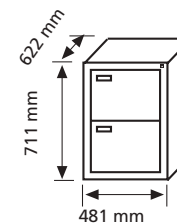

MOD. ARC-2C  
 COD. 20002

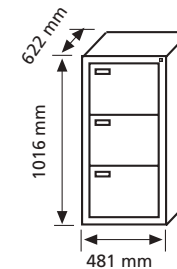

MOD. ARC-3C  
 COD. 20003

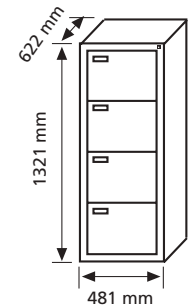

MOD. ARC-4C  
 COD. 20001

# ARCHIVADOR

OFFICE AND INDUSTRIAL CUPBOARDS

ARMOIRES DE BUREAU ET ATELIER

ARMÁRIOS DE ESCRITORIO



**MOD. A4**  
**COD. 20100**

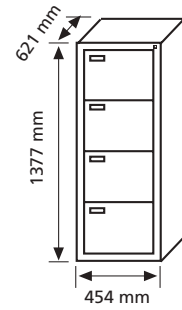

Cerradura de llave.  
Standard key lock.  
Serrure standard à clé.  
Fechadura standard de chave.



Sin montaje.  
Without assembly.  
Sans montage.  
Sem montagem.



Estructura soldada.  
Welded structure.  
Structure soudée.  
Estrutura soldada.



Pintado en Epoxi.  
Painted in Epoxy.  
Peinture en epoxi.  
Pintura em epoxi.



Color standard: Gris RAL 7035.  
Standard colour: Grey RAL 7035.  
Couleur standard: gris ral 7035.  
Cor standard: cinza ral 7035.



Metal.  
Metal.  
Metal.  
Metal.



# ARMARIO METÁLICO DE PERSIANA PVC

METAL CABINET WITH PVC ROLLING DOOR

ARMOAIRE METALLIQUE A RIDEAU PVC

ARMÁRIOS DE ESCRITORIO



Gran resistencia.  
Great resistance.  
Très résistant.  
Muito resistente.



Cerradura de llave.  
Standard key lock.  
Serrure standard à clé.  
Fechadura standard de chave.



Sin montaje.  
Without assembly.  
Pas de montage.  
Sem montagem.

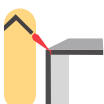

Estructura soldada.  
Welded structure.  
Structure soudée.  
Estrutura soldada.



Pintado en Epoxi.  
Painted in Epoxy.  
Peinture en epoxy.  
Pintura em epoxi.



Microtexturado.  
Microtextured.  
Microtexturé.  
Microtexturado.



Metal.  
Metal.  
Metal.  
Metal.



Color standard: Gris RAL 7035.  
Standard colour: Grey RAL 7035.  
Couleur standard: gris ral 7035.  
Cor standard: cinza ral 7035.

## COLORES OPCIONALES / OPTIONAL COLOURS / COULEURS EN OPTION / CORES OPCIONAIS

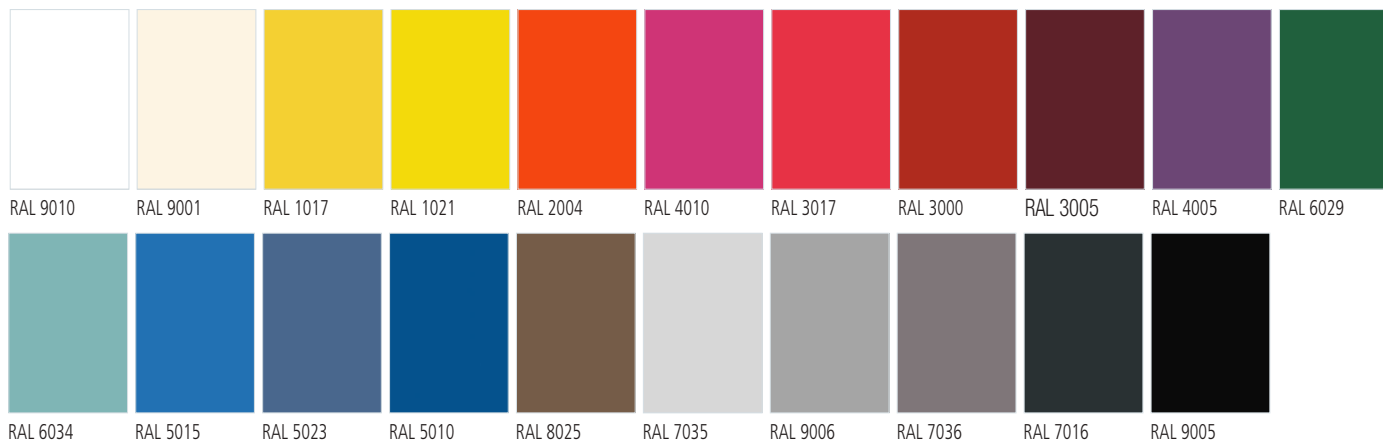

## PERSIANA / ROLLING DOOR / RIDEAU / ROLO CEGO



OTROS COLORES CONSULTAR  
OTHER COLOURS ON REQUEST  
AUTRES COULEURS SUR DEMANDE  
OUTRAS CORES PERGUNTAR

MOD. ARMP-19/1 • COD. 19810	MOD. ARMP-16/1 • COD. 16310	MOD. ARMP-13/1 • COD. 13410	MOD. ARMP-10/1 • COD. 10510	MOD. ARMP-07/1 • COD. 07510
MOD. ARMP-19/2 • COD. 19812	MOD. ARMP-16/2 • COD. 16312	MOD. ARMP-13/2 • COD. 13412	MOD. ARMP-10/2 • COD. 10512	MOD. ARMP-07/2 • COD. 07512

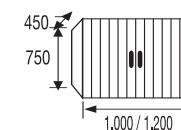
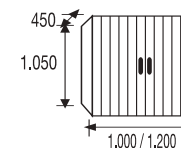
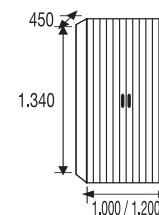
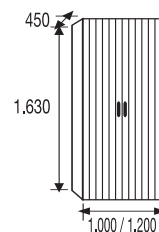
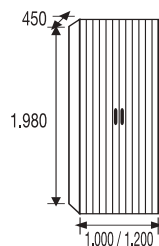

Unidades en milímetros / Units in millimeters / Unités en millimètres / Unidades em milímetros



**TIRADOR EMBUTIDO**  
Embossed handle  
Poignée encastrée  
Puxador embutido  
RAL 9005



**MOD. ARMP-19/2**  
COD. 19812



**REGULACIÓN EN ALTURA**  
Height adjustment  
Le réglage en hauteur  
Ajuste de altura



# ARMARIO DE OFICINA Y TALLER

OFFICE AND INDUSTRIAL CUPBOARDS

ARMOIRES DE BUREAU ET ATELIER

ARMARIOS DE ESCRITORIO

## CARACTERÍSTICAS TÉCNICAS

- Incluye cuatro bandejas (ARM01).
- Incluye dos bandejas (ARM05).
- Cerradura de tres puntos de cierre.

## FEATURES

- Delivered with four shelves included (ARM01).
- Delivered with two shelves included (ARM05).
- Three points locking.

## CARACTERISTIQUES TECHNIQUES

- Quatre tablettes inclus (ARM01).
- Deux tablettes inclus (ARM05).
- Fermeture trois points.

## CARACTERÍSTICAS TÉCNICAS

- Inclui quatro prateleiras (ARM01).
- Inclui duas prateleiras (ARM05).
- A fechadura fecha em três pontos.

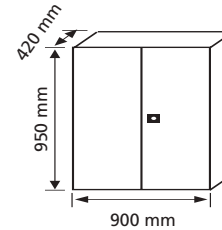

**MOD. ARM05**  
**COD. 90001**



Sin montaje.  
Without assembly.  
Pas de montage.  
Sem montagem.



Estructura soldada.  
Welded structure.  
Structure soudée.  
Estrutura soldada.



Pintado en Epoxi.  
Painted in Epoxy.  
Peinture en epoxi.  
Pintura em epoxi.



Microtexturado.  
Microtextured.  
Microtexturé.  
Microtexturado.



Metal.  
Metal.  
Metal.  
Metal.



Color standard: Gris RAL 7035.  
Standard colour: Grey RAL 7035.  
Couleur standard: Gris RAL 7035.  
Cor standard: Cinza RAL 7035.

## COLORES OPCIONALES / OPTIONAL COLOURS / COULEURS EN OPTION / CORES OPCIONAIS

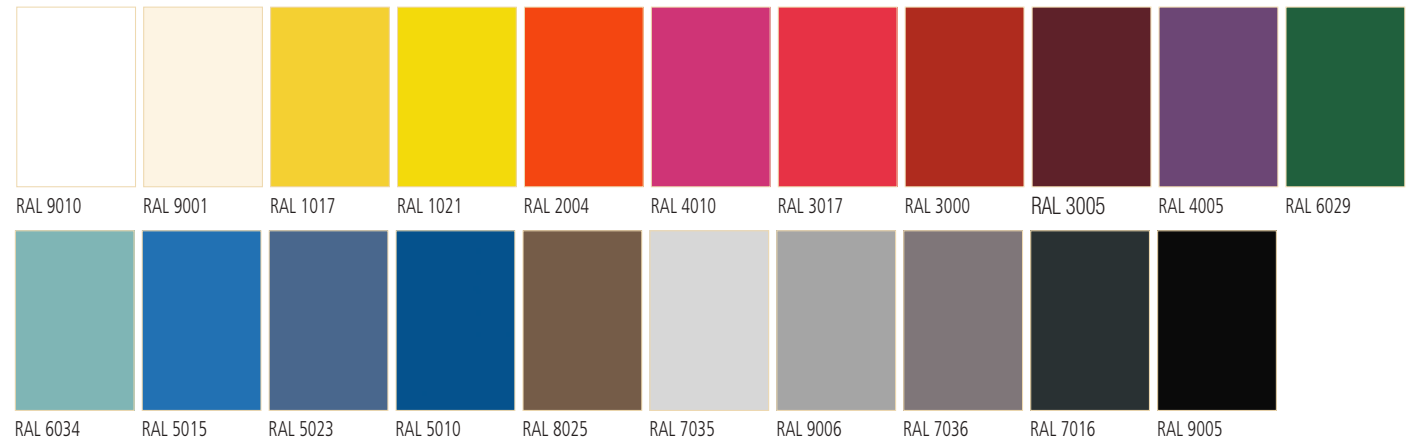



**MOD. ARM02**  
COD. 19002



**MOD. ARM03**  
COD. 19003



**MOD. ARM04**  
COD. 19004



**MOD. ARM06**  
COD. 19006



**MOD. ARM07**  
COD. 19007



**MOD. ARM08**  
COD. 19008



**MOD. ARM09**  
COD. 19009

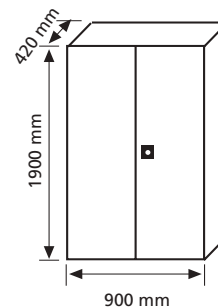

**MOD. ARM01**  
COD. 19001



OPCIÓN: ACERO INOXIDABLE  
OPTION: STAINLESS STEEL  
OPTION: ACIER INOXYDABLE  
OPÇÃO: AÇO INOXIDÁVEL

OPCIÓN: DESMONTABLES  
OPTION: DISASSEMBLED  
OPTION: DÉMONTABLE  
OPÇÃO: DESMONTÁVEL

# ARMARIO PLEGABLE

FOLDING CUPBOARD

VESTIAIRE PLIANT

ARMARIO DOBRÁVEL



Cerradura de llave.  
Standard key lock.  
Serrure standard à clé.  
Fechadura standard de chave.



Fácil montaje.  
Easy assembly.  
Montage facile.  
Fácil montagem.

**EPOXI**

Pintado en Epoxi.  
Painted in Epoxy.  
Peinture en epoxi.  
Pintura em epoxi.



Metal.  
Metal.  
Metal.  
Metal.



Color standard: Gris RAL 7035.  
Standard colour: Grey RAL 7035.  
Couleur standard: gris ral 7035.  
Cor standard: cinza ral 7035.

**MOD. APLE-1**  
**COD. 19100**

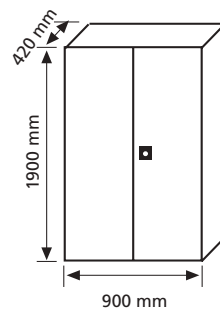

20 mm.











CONSIGNAS  
LEFT-LUGGAGE LOCKERS  
CONSIGNES  
CACIFOS



SERIE BANCO



SERIE MINI



SERIE  
SUPERMERCADO  
VERTICAL



SERIE  
SUPERMERCADO  
METACRILATO



SERIE  
SUPERMERCADO  
HORIZONTAL





SERIE  
MONOBLOK  
METACRILATO



SERIE  
MARCO AMARRE

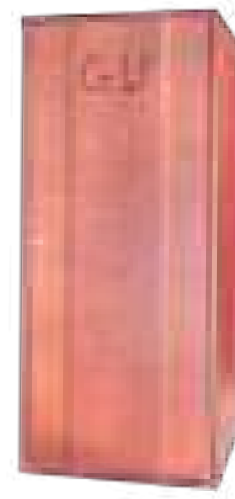

SERIE GOLF



SERIE MALETAS



CARACTERÍSTICAS / CHARACTERISTICS / CARACTERISTIQUES / CARACTERISTICAS



No es recomendable para espacios húmedos.  
Not recommended for wet spaces.  
Pas recommandé pour les environnements humides.  
Nao é recomendável para lugares com humidade.



Color standard: Gris RAL 7035.  
Standard colour: Grey RAL 7035.  
Couleur standard: gris ral 7035.  
Cor standard: cinza ral 7035.



Gran resistencia.  
Great resistance.  
Très résistant.  
Muito resistente.



Sin montaje.  
Without assembly.  
Pas de montage.  
Sem montagem.



Metal.  
Metal.  
Metal.  
Metal.



Estructura soldada.  
Welded structure.  
Structure soudée.  
Estrutura soldada.



Microtexturado.  
Microtextured.  
Microtexturé.  
Microtexturado.



Pintado en Epoxi.  
Painted in Epoxy.  
Peinture en epoxi.  
Pintura em epoxi.



Espesores.  
Thicknesses.  
Épaisseurs.  
Espessura.

OPCIONES / OPTIONS / OPTIONS / OPÇÕES

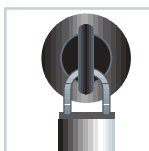

Pomo en poliamida  
(candado opcional)  
Padlockable Polyamide Lock  
(optional padlock)  
Poignée cadenassable en  
polyamide (cadenas en option)  
Fechadura de cadeado em poliamida



Pomo metálico (candado  
combinación opcional)  
Padlockable Metallic Lock  
(optional combination padlock)  
Poignée métallique (cadenas à  
combinaison en option)  
Fechadura de cadeado em metal



Cerradura de combinación y  
llave de emergencia  
Lock of 4 manual digits with  
emergency key  
Serrure à combinaison et clef  
de émergence  
Fechadura de combinação e  
chave de emergência



Monedero (moneda retornable).  
Coin-operated Lock (coin-return).  
Monnayeur (monnaie réversible).  
Moedeiro (moeda retornável).

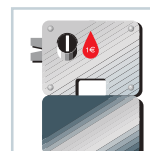

Monedero + cajetín depósito.  
Coin-operated Lock + Coin Collect  
Box (cash box, non coin-return).  
Monnayeur + tirelire (monnaie  
non réversible).  
Moedeiro + caixinha para as  
moedas.



Cerradura electrónica de  
combinación de 4 dígitos.  
Electronic lock combination  
of 4 digits.  
Serrure électronique à  
combinaison de 4 chiffres.  
Fechadura electrónica,  
combinação de 4 dígitos.



Cerradura de proximidad  
Lock of proximity  
Serrure de proximité  
Fechadura de proximidade



Cerradura electrónica de  
combinación de 4 dígitos.  
Electronic lock combination  
of 4 digits.  
Serrure électronique à  
combinaison de 4 chiffres.  
Fechadura electrónica,  
combinação de 4 dígitos.



Cerradura electrónica de combinación  
de 4 dígitos.  
Electronic lock combination of 4 digits.  
Serrure électronique à combinaison  
de 4 chiffres.  
Fechadura electrónica, combinação  
de 4 dígitos.



Cerradura de proximidad  
Lock of proximity  
Serrure de proximité  
Fechadura de  
proximidade



Cerradura de proximidad  
Lock of proximity  
Serrure de proximité  
Fechadura de  
proximidade



Cerradura electrónica de combinación  
de 4 dígitos.  
Electronic lock combination of 4 digits.  
Serrure électronique à combinaison  
de 4 chiffres.  
Fechadura electrónica, combinação  
de 4 dígitos.



Cerradura electrónica de combinación  
de 4 dígitos.  
Electronic lock combination of 4 digits.  
Serrure électronique à combinaison  
de 4 chiffres.  
Fechadura electrónica, combinação  
de 4 dígitos.

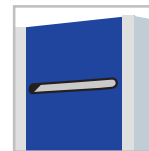

Ranura buzón. Puertas sin ventilación  
Mailbox Slot. Doors without vent system  
Rainure pour boîte à lettres. Portes sans  
volet d'aération  
Obertura para cartas. Portas sem  
ventilação



Placa de numeración.  
Numeration plate.  
Plaque numérique.  
Placa de numeração.

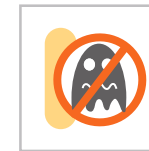

Pintura antibacteriana  
Antibacterial paint  
De la peinture  
antibactérienne  
Tinta antibacteriana

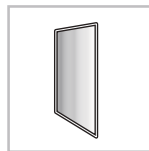

Espejo  
Mirror  
Miroir  
Espelho



Pulsera de nylon  
Bracelet of nylon  
Bracelet en nylon  
Pulseira de náilon



Pulsera elástica  
Elastic Bracelet  
Bracelet élastique  
Pulseira elástica

**COLORES OPCIONALES PUERTAS**

OPTIONAL DOORS COLOURS

COULEURS PORTES OPTION

CORES DE PORTAS OPCIONAIS

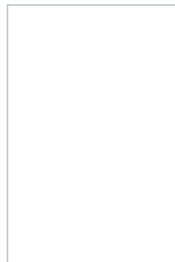

RAL 9010

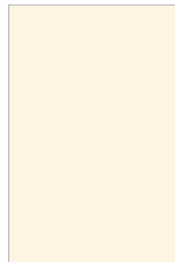

RAL 9001



RAL 1017



RAL 1021



RAL 2004



RAL 4010



RAL 3017



RAL 3000



RAL 3005



RAL 4005



RAL 6029



RAL 6034



RAL 5015



RAL 5023



RAL 5010



RAL 8025

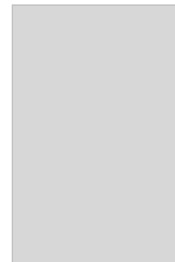

RAL 7035



RAL 9006



RAL 7036



RAL 7016



RAL 9005

# SERIE BANCO

BANCO SERIES  
SÉRIE BANCO  
SÉRIE BANCO



MOD. TBC03P  
COD. 91300



MOD. CBC04P  
COD. 91402

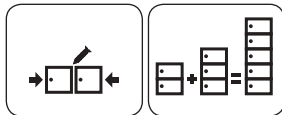

COD.	MOD.	↑↓	↔	↗↘	□	🔒	👤	📏	kg	M <sup>3</sup>
91400	TBC04P	915	275	440	4	✓	-	16,0	0,11	
91402	CBC04P	915	275	440	4	-	✓	17,5	0,11	
91300	TBC03P	690	275	440	3	✓	-	13,0	0,08	
91302	CBC03P	690	275	440	3	-	✓	14,0	0,08	

Unidades en milímetros / Units in millimeters / Unités en millimètres / Unidades em milímetros

## SERIE MINI

MINI SERIES  
SÉRIE MINI  
SÉRIE MINI



**MOD. CMIN3P**  
COD. 91102



**MOD. TMIN4P**  
COD. 91200



**MOD. MINI5P**  
COD. 91000

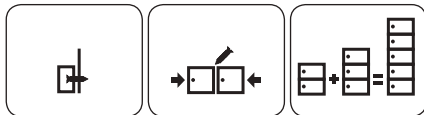

COD.	MOD.	↑↓	↔	↗↘	□	🔑	🔒	📏	kg	M <sup>3</sup>
91200	TMIN4P	915	275	200	4	✓	-	12,0	0,05	
91202	CMIN4P	915	275	200	4	-	✓	13,5	0,05	
91100	TMIN3P	690	275	200	3	✓	-	9,0	0,04	
91102	CMIN3P	690	275	200	3	-	✓	10,0	0,04	
91000	MINI5P	750	200	200	5	✓	-	9,0	0,03	

Unidades en milímetros / Units in milimeters / Unités en milimètres / Unidades em milímetros

## SERIE SUPERMERCADO VERTICAL

SUPERMERCADO VERTICAL SERIES

SÉRIE SUPERMERCADO VERTICAL

SÉRIE SUPERMERCADO VERTICAL



**MOD. CSVS1P**  
COD. 95502



**MOD. TSVS2P**  
COD. 95400



**MOD. CSVZ2P**  
COD. 95302

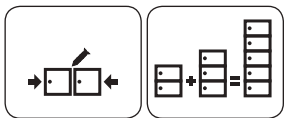

COD.	MOD.	↑↓	↔	↗↘	□	🔒	👤	📏	kg	M <sup>3</sup>
95300	TSVZ2P	925	300	400	2	✓	–	13,0	0,11	
95302	CSVZ2P	925	300	400	2	–	✓	14,0	0,11	
95400	TSVS2P	800	300	400	2	✓	–	12,0	0,10	
95402	CSVS2P	800	300	400	2	–	✓	13,0	0,10	
95500	TSVS1P	400	300	400	1	✓	–	7,0	0,05	
95502	CSVS1P	400	300	400	1	–	✓	7,5	0,05	

Unidades en milímetros / Units in milimeters / Unités en milimètres / Unidades em milímetros



## SERIE SUPERMERCADO HORIZONTAL

SUPERMERCADO HORIZONTAL SERIES  
SÉRIE SUPERMERCADO HORIZONTAL  
SÉRIE SUPERMERCADO HORIZONTAL



MOD. TSH2P  
COD. 95100



MOD. CSH3P  
COD. 95202



## SERIE MAXI

MAXI SERIES  
SÉRIE MAXI  
SÉRIE MAXI



MOD. TSVS2P MAXI  
COD. 95600



MOD. CMAXI1P  
COD. 97300



COD.	MOD.	↑↓	↔	↗↘	□	🔑	🔒	📦	kg	M <sup>3</sup>
95200	TSH3P	410	870	400	3	✓	-	19,0	0,14	
95202	CSH3P	410	870	400	3	-	✓	21,0	0,14	
95100	TSH2P	410	580	400	2	✓	-	12,0	0,09	
95102	CSH2P	410	580	400	2	-	✓	13,0	0,09	

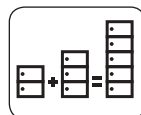
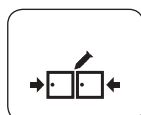

COD.	MOD.	↑↓	↔	↗↘	□	🔑	🔒	📦	kg	M <sup>3</sup>
97305	TMAXI1P	1170	300	500	1	✓	-	12,0	0,18	
97300	CMAXI1P	1170	300	500	1	-	✓	13,0	0,18	
95600	TSV2P MAXI	800	300	500	2	✓	-	14,0	0,12	
95602	CSV2P MAXI	800	300	500	2	-	✓	15,0	0,12	

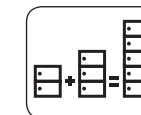
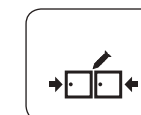

Unidades en milímetros / Units in millimeters / Unités en millimètres / Unidades em milímetros

Unidades en milímetros / Units in millimeters / Unités en millimètres / Unidades em milímetros

# SERIE SUPERMERCADO METACRILATO

SUPERMERCADO METACRILATO SERIES  
SÉRIE SUPERMERCADO METACRILATO  
SÉRIE SUPERMERCADO METACRILATO



MOD. CSVS1PME  
COD. 95503



MOD. CSVS2PME  
COD. 95403



MOD. TSVZ2PME  
COD. 95333

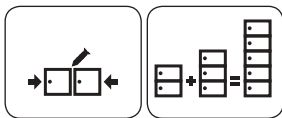

COD.	MOD.	↑	↔	↗	□	🔒	🛒	kg	M <sup>3</sup>
95333	TSVZ2PME	925	300	400	2	✓	–	14,0	0,11
95303	CSVZ2PME	925	300	400	2	–	✓	15,0	0,11
95433	TSVS2PME	800	300	400	2	✓	–	13,0	0,10
95403	CSVS2PME	800	300	400	2	–	✓	14,0	0,10
95533	TSVS1PME	400	300	400	1	✓	–	8,0	0,05
95503	CSVS1PME	400	300	400	1	–	✓	8,5	0,05

Unidades en milímetros / Units in millimeters / Unités en millimètres / Unidades em milímetros

# SERIE MONOBLOK METACRILATO

MONOBLOCK METACRILATO SERIES  
 MONOBLOCK METACRILATO SERIES  
 SÉRIE MONOBLOCK METACRILATO



4

22,0 0,19 <p>COD: 42802 MOD: CM2P1200-S</p>	44,0 0,38 <p>COD: 42812 MOD: CM2P1200-D</p>	25,0 0,26 <p>COD: 42902 MOD: CM2P1600-S</p>	28,0 0,26 <p>COD: 42913 MOD: CM4P1600-S</p>	53,0 0,51 <p>COD: 42912 MOD: CM3P1600-D</p>
24,0 0,19 <p>COD: 42803 MOD: CM3P1200-S</p>	48,0 0,38 <p>COD: 42813 MOD: CM3P1200-D</p>	26,0 0,26 <p>COD: 42904 MOD: CM3P1600-S</p>	50,0 0,51 <p>COD: 42903 MOD: CM2P1600-D</p>	55,0 0,51 <p>COD: 42914 MOD: CM4P1600-D</p>

MOD. CM3P1600-D  
 COD. 42912



# SERIE MARCO AMARRE

MARCO AMARRE SERIES  
SÉRIE MARCO AMARRE  
SÉRIE MARCO AMARRE

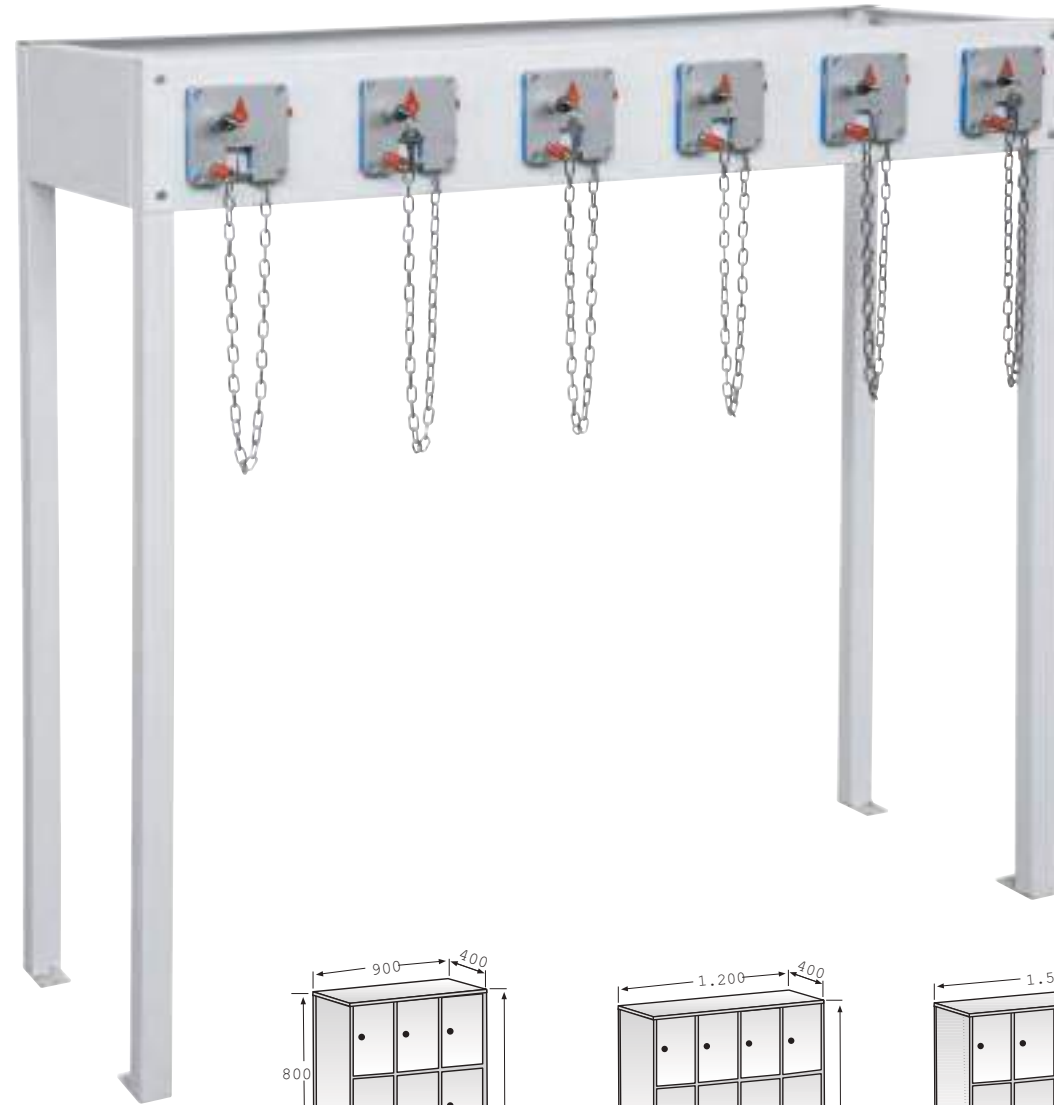

MOD. MA4P1500  
COD. 90422

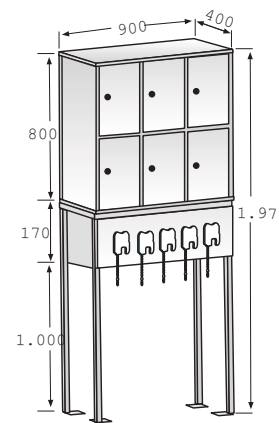

3 CSV2P + 1 MA900

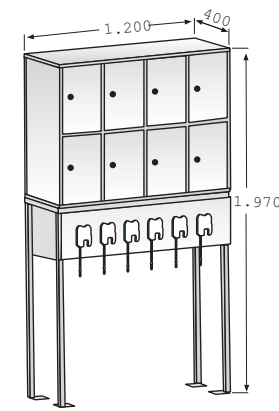

4 CSVS2P + 1 MA1200

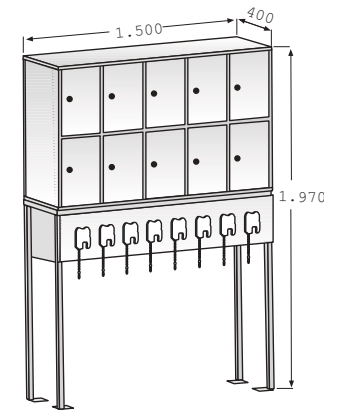

5 CSVS2P + 1 MA1500

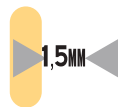
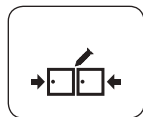

COD.	MOD.	↑↓	↔	↗↘	🔑	kg	M <sup>3</sup>
90222	MA4P900	1170	900	400	5	18,5	0,08
90322	MA4P1200	1170	1200	400	6	21,0	0,09
90422	MA4P1500	1170	1500	400	8	23,5	0,10

Unidades en milímetros / Units in millimeters / Unités en millimètres / Unidades em milímetros

## SERIE GOLF

GOLF SERIES  
SÉRIE GOLF  
SÉRIE GOLF

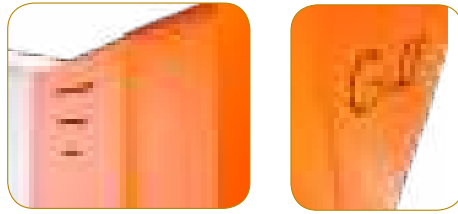

MOD. CGOLF1P  
COD. 99500



MOD. TGOLF1P  
COD. 99600

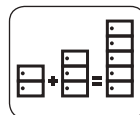
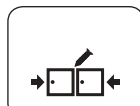

COD.	MOD.	↑	↔	↗	🔒	🧑	📊	M <sup>3</sup>
99500	CGOLF1P	1240	500	600	-	✓	22,0	0,37
99600	TGOLF1P	1240	500	600	✓	-	21,0	0,37

Unidades en milímetros / Units in millimeters / Unités en millimètres / Unidades em milímetros

## SERIE MALETAS

SUITCASE SERIES  
SÉRIE VALISES  
SÉRIE MALAS



MOD. CMAL1P  
COD. 97500



OPCIÓN: FENÓLICO  
OPTION: HPL  
OPTION: STRATIFIE COMPACT  
OPÇÃO: RESINAS FENÓLICAS

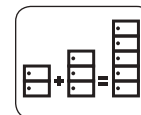
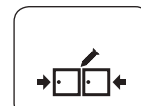

COD.	MOD.	↑	↔	↗	🔒	🧑	📊	M <sup>3</sup>
97500	CMAL1P	900	500	700	-	✓	39,0	0,31

Unidades en milímetros / Units in millimeters / Unités en millimètres / Unidades em milímetros



# SERIE 350

350 SERIES  
SÉRIE 350  
SÉRIE 350



**MOD. CON351**  
COD. 35011



**MOD. DEP352**  
COD. 35020



**MOD. CON353**  
COD. 35031



**DEP353**

+

**CON352**

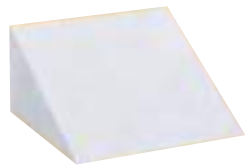

**SOBRETECHO**  
SLOPE TOP / TOIT INCLINÉ /  
SOBRETETO COM PEQUENA  
INCLINAÇÃO

**MOD. SOB350**  
COD. 35100



**ZÓCALO**  
BASE / SOCLE / SOCLIO

**MOD. ZOC350**  
COD. 35000

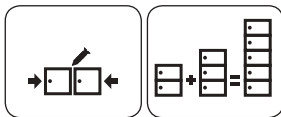

COD.	MOD.	↑	↔	↗	□	🔒	🔥	kg	M <sup>3</sup>
35030	DEP353	1050	350	350	3	✓	-	21,0	0,13
35031	CON353	1050	350	350	3	-	✓	22,0	0,13
35020	DEP352	700	350	350	2	✓	-	14,0	0,09
35021	CON352	700	350	350	2	-	✓	16,0	0,09
35010	DEP351	350	350	350	1	✓	-	7,0	0,04
35011	CON351	350	350	350	1	-	✓	8,0	0,04

Unidades en milímetros / Units in millimeters / Unités en millimètres / Unidades em milímetros

## SERIE 400

400 SERIES  
SÉRIE 400  
SÉRIE 400



**MOD. CON402**  
COD. 40021

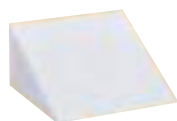

**SOBRETECHO**  
SLOPE TOP / TOIT INCLINÉ /  
SOBRETETO COM PEQUENA  
INCLINAÇÃO

**MOD. SOB400**  
COD. 40100



**ZÓCALO**  
BASE / SOCLE / SOCLO  
**MOD. ZOC400**  
COD. 40000

## SERIE 500

500 SERIES  
SÉRIE 500  
SÉRIE 500



**MOD. DEP1B**  
COD. 50035



**MOD. DEP2B**  
COD. 50015



## SERIE MINIBOX

MINIBOX SERIES  
SÉRIE MINIBOX  
SÉRIE MINIBOX



**MOD. BOX8P**  
COD. 11301



## SERIE LOCKER

LOCKER SERIES  
SÉRIE LOCKER  
SÉRIE LOCKER



**MOD. LOC300**  
COD. 30010



COD.	MOD.	↑	↔	↗	□	🔒	🔥	kg	M <sup>3</sup>
40020	DEP402	900	400	500	2	✓	–	15,0	0,18
40021	CON402	900	400	500	2	–	✓	16,0	0,18
50015	DEP2B	700	350	350	1	✓	–	14,0	0,09
50035	DEP1B	1050	350	350	1	✓	–	16,0	0,13
30010	LOC300	500	300	450	1	✓	–	8,0	0,07
11301	BOX8P	1130	345	350	8	✓	–	22,0	0,14

Unidades en milímetros / Units in milimeters / Unités en milimètres / Unidades em milímetros

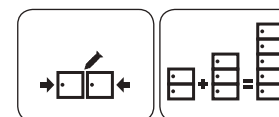



3 uds. DEP 353 + 3 uds. DEP 352





MOD. CAS431  
COD. 35431



MOD. CAS433  
COD. 35433



COD.	MOD.	↑↓	↔	↗↘	+	🔒	👤	kg	M <sup>3</sup>
35431	CAS431	200	430	350	1	✓	–	4,0	0,031
35432	CAS432	383	430	350	2	✓	–	7,0	0,058
35433	CAS433	565	430	350	3	✓	–	10,0	0,085

Unidades en milímetros / Units in millimeters / Unités en millimètres / Unidades em milímetros













TAQUILLAS EN MELAMINA

LOCKERS IN MELAMINE

VESTIAIRES EN MÉLAMINE

CACIFOS FOLHEADO A MADEIRA DE TOLA

CARACTERÍSTICAS / CHARACTERISTICS / CARACTERISTIQUES / CARACTERISTICAS



Espesores.  
Thicknesses.  
Épaisseurs.  
Espessura.



Sin montaje.  
Without assembly.  
Pas de montage.  
Sem montagem.



Pata regulable en altura.  
Legs adjustable in height.  
Pieds réglables en hauteur.  
Pés reguláveis em altura.



Cuerpo.  
Body.  
Corps.  
Corpo.

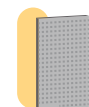

Trasera en tablex perforado y totalmente enmarcada.  
Back panel made of perforated tablex and totally framed.  
Partie arrière en tablex perforé et totalement encadrée.  
Parte de atrás construída em tablex perfurado e totalmente encaixada.



Placa de numeración incluida.  
Numeration plate included.  
Plaque numérique inclus.  
Placa de numeração inclusa.



Canteado PVC.  
PVC-Edged.  
Finitions en PVC.  
Finição em PVC.



Gran resistencia.  
Great resistance.  
Très résistant.  
Muito resistente.



No es recomendable para espacios extremadamente húmedos.  
Not recommended for extremely wet environment.  
Pas recommandé pour les environnements extrêmement humides.  
Nao é recomendável para ambiente extremamente úmido.

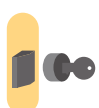

Cerradura de resbalón con bombillo extraíble y llave maestra.  
Latch operated lock with removable cylinder and master key.  
Serrure à plaquer avec cylindre enlevable et clé passe.  
Fechadura de segurança com possibilidade de tirar o cilindro e chave mestre.

OPCIONES / OPTIONS / OPTIONS / OPÇÕES

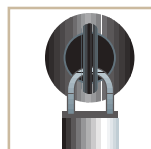

Pomo en poliamida (candado opcional)  
Padlockable Polyamide Lock (optional padlock)  
Poignée cadénassable en polyamide (cadenas en option)  
Fechadura de cadeado em poliamida



Pomo metálico (candado combinación opcional)  
Padlockable Metallic Lock (optional combination padlock)  
Poignée métallique (cadenas à combinaison en option)  
Fechadura de cadeado em metal



Monedero (moneda retornable).  
Coin-operated Lock (coin-return).  
Monnayeur (monnaie réversible).  
Moedeiro (moeda retornável).

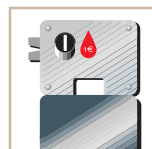

Monedero + cajetín depósito.  
Coin-operated Lock + Coin Collect Box (cash box, non coin-return).  
Monnayeur + tirelire (monnaie non réversible).  
Moedeiro + caixinha para as moedas.



Cerradura electrónica de combinación de 4 dígitos.  
Electronic lock combination of 4 digits.  
Serrure électronique à combinaison de 4 chiffres.  
Fechadura electrónica, combinação de 4 dígitos.



Cerradura de proximidad  
Lock of proximity  
Serrure de proximité  
Fechadura de proximidade



Cerradura electrónica de combinación de 4 dígitos.  
Electronic lock combination of 4 digits.  
Serrure électronique à combinaison de 4 chiffres.  
Fechadura electrónica, combinação de 4 dígitos.



Cerradura electrónica de combinación de 4 dígitos.  
Electronic lock combination of 4 digits.  
Serrure électronique à combinaison de 4 chiffres.  
Fechadura electrónica, combinação de 4 dígitos.



Cerradura de combinación y llave de emergencia  
Lock of 4 manual digits with emergency key  
Serrure à combinaison et clef de émergence  
Fechadura de combinação e chave de emergência



Cerradura electrónica de combinación de 4 dígitos.  
Electronic lock combination of 4 digits.  
Serrure électronique à combinaison de 4 chiffres.  
Fechadura electrónica, combinação de 4 dígitos.



Cerradura electrónica de combinación de 4 dígitos.  
Electronic lock combination of 4 digits.  
Serrure électronique à combinaison de 4 chiffres.  
Fechadura electrónica, combinação de 4 dígitos.

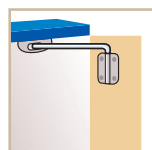

Retenedor de puerta a 90°  
Door opening limiter 90°  
Entrebâilleur de porte à 90 degrés  
Retentor para porta a 90 graus



Bisagra con freno  
Hinge with brake  
Charnière avec frein  
Dobradiça com freio

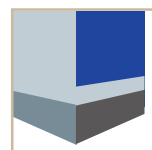

Zócalo melamina  
Melamine Socle  
Mélamine Socle  
Base de melamina



Lateral embellecedor  
Decorative end panel  
Enjoliveur latéral  
Lateral de finishing

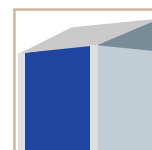

Sobretecho inclinado  
Slope Top  
Toit incliné  
Sobretecho com pequena inclinação



Cerradura de proximidad  
Lock of proximity  
Serrure de proximité  
Fechadura de proximidade



Cerradura de proximidad  
Lock of proximity  
Serrure de proximité  
Fechadura de proximidade



Cierre para candado  
Closing for padlock  
Fermeture pour cadenas  
Fechadura para cadeado

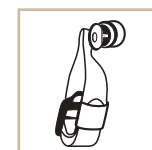

Pulsera de nylon  
Bracelet of nylon  
Bracelet en nylon  
Pulseira de náilon



Pulsera elástica  
Elastic Bracelet  
Bracelet élastique  
Pulseira elástica

## COLORES STANDARD PUERTAS

STANDARD DOORS COLOURS  
COULEURS PORTES STANDARD  
CORES DE PORTAS STANDARD

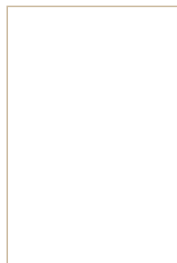

MBLANCO-1

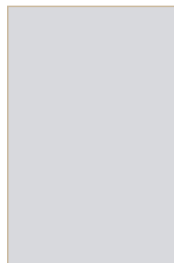

MV-157

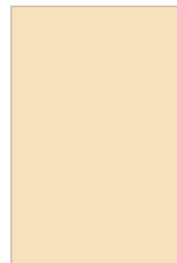

MG-097



MY-115



MN-035



MW-035



MX-017



MZ-025

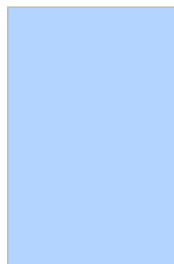

MA-100



MA-200



MA-035



MH-021

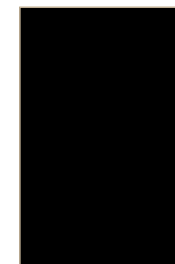

MM-168



MM-240 Haya



MM-500 Nogal



MM-100 Wengue



MM-150 Acacia



MM-160 Roble ceniza



MM-600 Roble claro



MM-650 Roble oscuro



MM-700 Razor claro



MM-800 Entelado claro



MM-850 Entelado oscuro

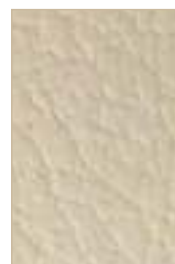

MM-900 Cuero claro

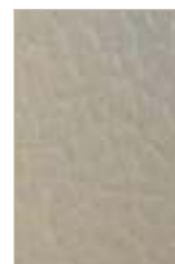

MM-950 Cuero oscuro



Blanco brillo



Negro brillo



**OTROS COLORES CONSULTAR**  
OTHER COLOURS ON REQUEST  
AUTRES COULEURS SUR DEMANDE  
OUTRAS CORES PERGUNTAR





SERIE **MV**



SERIE **MT**



SERIE **MM**



SERIE **MC**



SERIE MP



SERIE MB



SERIE MZ

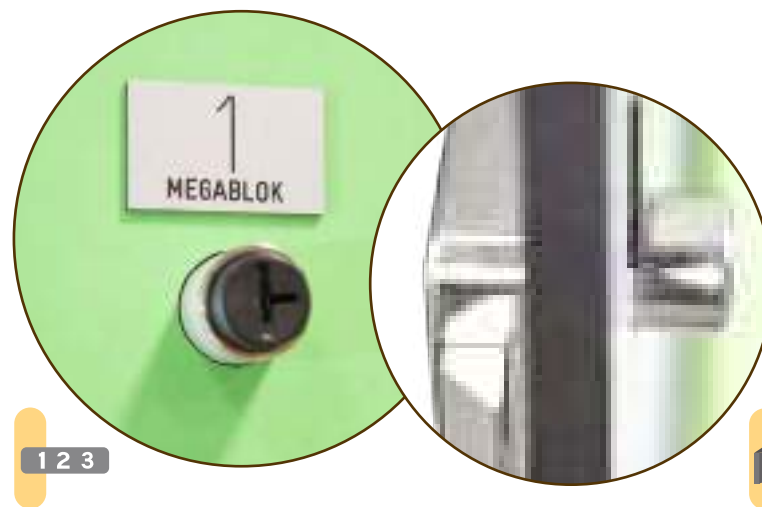



SERIE MV



SERIEMV

MV-30/1 COD. 99276	MV-30/2 COD. 99278	MV-30/3 COD. 99279	MV-30/4 COD. 99280	MV-40/1 COD. 99283	MV-40/2 COD. 99284	MV-40/3 COD. 99285
32Kg. • 0,28m <sup>3</sup>	54Kg. • 0,54m <sup>3</sup>	77Kg. • 0,80m <sup>3</sup>	99Kg. • 1,07m <sup>3</sup>	36Kg. • 0,37m <sup>3</sup>	62Kg. • 0,72m <sup>3</sup>	89Kg. • 1,07m <sup>3</sup>

SERIEMT

MT-30/1 COD. 99277	MT-30/2 COD. 99578	MT-30/3 COD. 99579	MT-30/4 COD. 99580	MT-40/1 COD. 99352	MT-40/2 COD. 99402	MT-40/3 COD. 99403
33Kg. • 0,28m <sup>3</sup>	55Kg. • 0,54m <sup>3</sup>	78Kg. • 0,80m <sup>3</sup>	101Kg. • 1,07m <sup>3</sup>	36Kg. • 0,37m <sup>3</sup>	63Kg. • 0,72m <sup>3</sup>	90Kg. • 1,07m <sup>3</sup>

SERIEMM

MM-30/1 COD. 99350	MM-30/2 COD. 99412	MM-30/3 COD. 99413	MM-30/4 COD. 99414	MM-40/1 COD. 99353	MM-40/2 COD. 99415	MM-40/3 COD. 99416
35Kg. • 0,28m <sup>3</sup>	60Kg. • 0,54m <sup>3</sup>	84Kg. • 0,80m <sup>3</sup>	110Kg. • 1,07m <sup>3</sup>	39Kg. • 0,37m <sup>3</sup>	68Kg. • 0,72m <sup>3</sup>	98Kg. • 1,07m <sup>3</sup>

SERIEMC

MC-30/1 COD. 99351	MC-30/2 COD. 99422	MC-30/3 COD. 99423	MC-30/4 COD. 99424	MC-40/1 COD. 99354	MC-40/2 COD. 99425	MC-40/3 COD. 99426
37Kg. • 0,28m <sup>3</sup>	64Kg. • 0,54m <sup>3</sup>	91Kg. • 0,80m <sup>3</sup>	118Kg. • 1,07m <sup>3</sup>	42Kg. • 0,37m <sup>3</sup>	74Kg. • 0,72m <sup>3</sup>	106Kg. • 1,07m <sup>3</sup>



SERIEM P

MP-30/1 COD. 99551    MP-30/2 COD. 99552    MP-30/3 COD. 99553    MP-30/4 COD. 99555    MP-40/1 COD. 99554    MP-40/2 COD. 99559    MP-40/3 COD. 99560

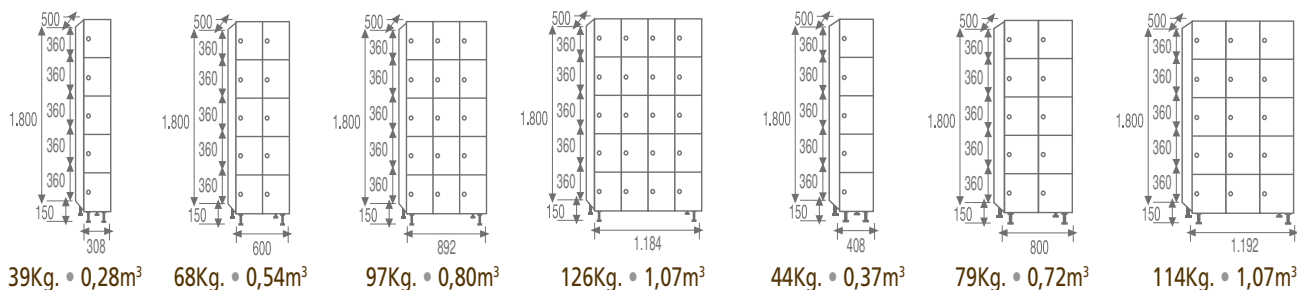

MB-30/1 COD. 99651    MB-30/2 COD. 99652    MB-30/3 COD. 99653    MB-30/4 COD. 99655    MB-40/1 COD. 99654    MB-40/2 COD. 99659    MB-40/3 COD. 99660

SERIEM B

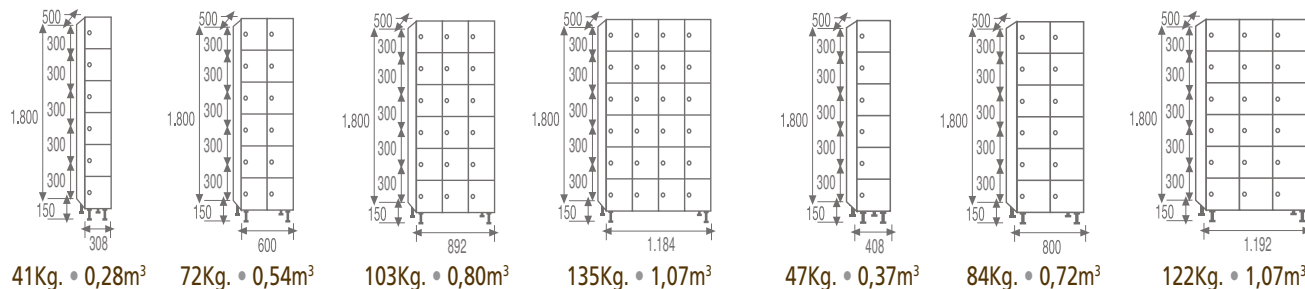

MZ-30/1 COD. 99851    MZ-30/2 COD. 99852    MZ-30/3 COD. 99853    MZ-30/4 COD. 99855    MZ-40/1 COD. 99854    MZ-40/2 COD. 99859    MZ-40/3 COD. 99860

SERIEM Z

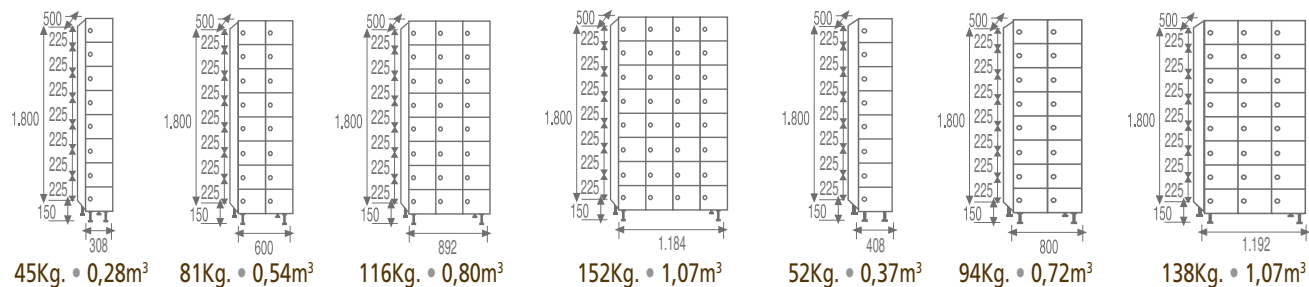





# TAQUILLAS CUERPO MELAMINA HIDRÓFUGA Y PUERTAS FENÓLICAS

LOCKERS WITH BODY IN HYDROPHOBIC MELAMINE AND HPL DOORS

VESTIAIRES CORP EN MÉLAMINÉ HYDROFUGE ET PORTES EN STRATIFIÉ COMPACT

CACIFOS CORPO DE MELAMINA HIDRÓFUGA E PORTAS FENÓLICAS

CARACTERÍSTICAS / CHARACTERISTICS / CARACTERISTIQUES / CARACTERISTICAS



Tornillería y bisagras en acero inoxidable.  
Screws and hinges in stainless steel.  
Vis et charnières en acier inoxydable.  
Parafusos e dobradiças em aço inox.

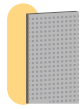

Trasera en tablex perforado y totalmente enmarcada.  
Back panel made of perforated tablex and totally framed.  
Partie arrière en tablex perforé et totalement encadrée.  
Parte de atrás construída em tablex perfurado e totalmente encaixada.



Recomendado para ambientes húmedos. Resistente al agua. Waterproof.  
Recommended for wet areas. Waterproof.  
Récommandé pour les environnements humides.  
Recomendado para lugares com humidade. Resistente a água.



Cerradura de resbalón con bombillo extraíble y llave maestra.  
Latch operated lock with removable cylinder and master key.  
Serrure à plaquer avec cylindre enlevable et clé passe.  
Fechadura de segurança com possibilidade de tirar o cilindro e chave mestre.



Espesores / Cuerpo.  
Thicknesses / Body.  
Épaisseurs / Corp.  
Espessura / Corpo.



Placa de numeración incluida.  
Numeration plate included.  
Plaque numérique inclus.  
Placa de numeração inclusa.



Cuerpo.  
Body.  
Corps.  
Corpo.



Fácil limpieza.  
Easy cleaning.  
Nettoyage facile.  
Fácil limpeza.



Espesores / Puerta.  
Thicknesses / Door.  
Épaisseurs / Porte.  
Espessura / Porta.



Pata regulable en altura.  
Legs adjustable in height.  
Pieds réglables en hauteur.  
Pés reguláveis em altura.



Cantos redondeados.  
Rounded edges.  
Sans arête vive.  
Cantos arredondados.



Gran resistencia.  
Great resistance.  
Très résistant.  
Muito resistente.

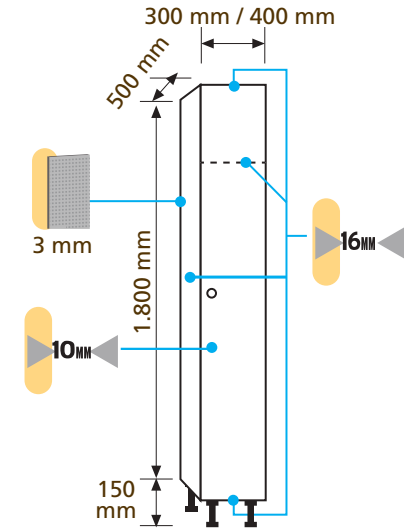

OPCIONES / OPTIONS / OPTIONS / OPÇÕES

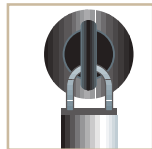

Pomo en poliamida (candado opcional)  
Padlockable Polyamide Lock (optional padlock)  
Poignée cadenasable en polyamide (cadenas en option)  
Fechadura de cadeado em poliamida



Pomo metálico (candado combinación opcional)  
Padlockable Metallic Lock (optional combination padlock)  
Poignée métallique (cadenas à combinaison en option)  
Fechadura de cadeado em metal



Monedero (moneda retornable).  
Coin-operated Lock (coin-return).  
Monnayeur (monnaie réversible).  
Moedeiro (moeda retornável).



Monedero + cajetín depósito.  
Coin-operated Lock + Coin Collect Box (cash box, non coin-return).  
Monnayeur + tirelire (monnaie non réversible).  
Moedeiro + caixinha para as moedas.



Cerradura electrónica de combinación de 4 dígitos.  
Electronic lock combination of 4 digits.  
Serrure électronique à combinaison de 4 chiffres.  
Fechadura electrónica, combinação de 4 dígitos.



Cerradura de proximidad  
Lock of proximity  
Serrure de proximité  
Fechadura de proximidade



Cerradura electrónica de combinación de 4 dígitos.  
Electronic lock combination of 4 digits.  
Serrure électronique à combinaison de 4 chiffres.  
Fechadura electrónica, combinação de 4 dígitos.



Cerradura electrónica de combinación de 4 dígitos.  
Electronic lock combination of 4 digits.  
Serrure électronique à combinaison de 4 chiffres.  
Fechadura electrónica, combinação de 4 dígitos.



Cerradura de proximidad  
Lock of proximity  
Serrure de proximité  
Fechadura de proximidade



Cerradura de proximidad  
Lock of proximity  
Serrure de proximité  
Fechadura de proximidade



Cerradura de combinación y llave de emergencia  
Lock of 4 manual digits with emergency key  
Serrure à combinaison et clef de émergence  
Fechadura de combinação e chave de emergência



Cerradura electrónica de combinación de 4 dígitos.  
Electronic lock combination of 4 digits.  
Serrure électronique à combinaison de 4 chiffres.  
Fechadura electrónica, combinação de 4 dígitos.



Cerradura electrónica de combinación de 4 dígitos.  
Electronic lock combination of 4 digits.  
Serrure électronique à combinaison de 4 chiffres.  
Fechadura electrónica, combinação de 4 dígitos.



Bisagra a 180°  
180° hinge opening  
Charnière a 180°  
Dobradiça a 180°

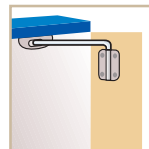

Retenedor de puerta a 90°  
Door opening limiter 90°  
Entrebâilleur de porte à 90 degrés  
Retentor para porta a 90 graus

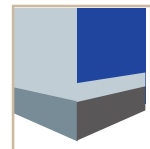

Zócalo melamina  
Melamine Socle  
Mélamine Socle  
Base de melamina



Lateral embellecedor  
Decorative end panel  
Enjoliveur latéral  
Lateral de feinição

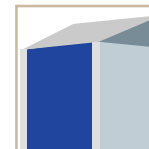

Sobretecho inclinado  
Slope Top  
Toit incliné  
Sobretecho com pequena inclinação



Cierre para candado  
Closing for padlock  
Fermeture pour cadenas  
Fechadura para cadeado

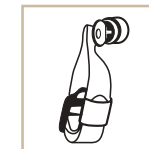

Pulsera de nylon  
Bracelet of nylon  
Bracelet en nylon  
Pulseira de náilon



Pulsera elástica  
Elastic Bracelet  
Bracelet élastique  
Pulseira elástica

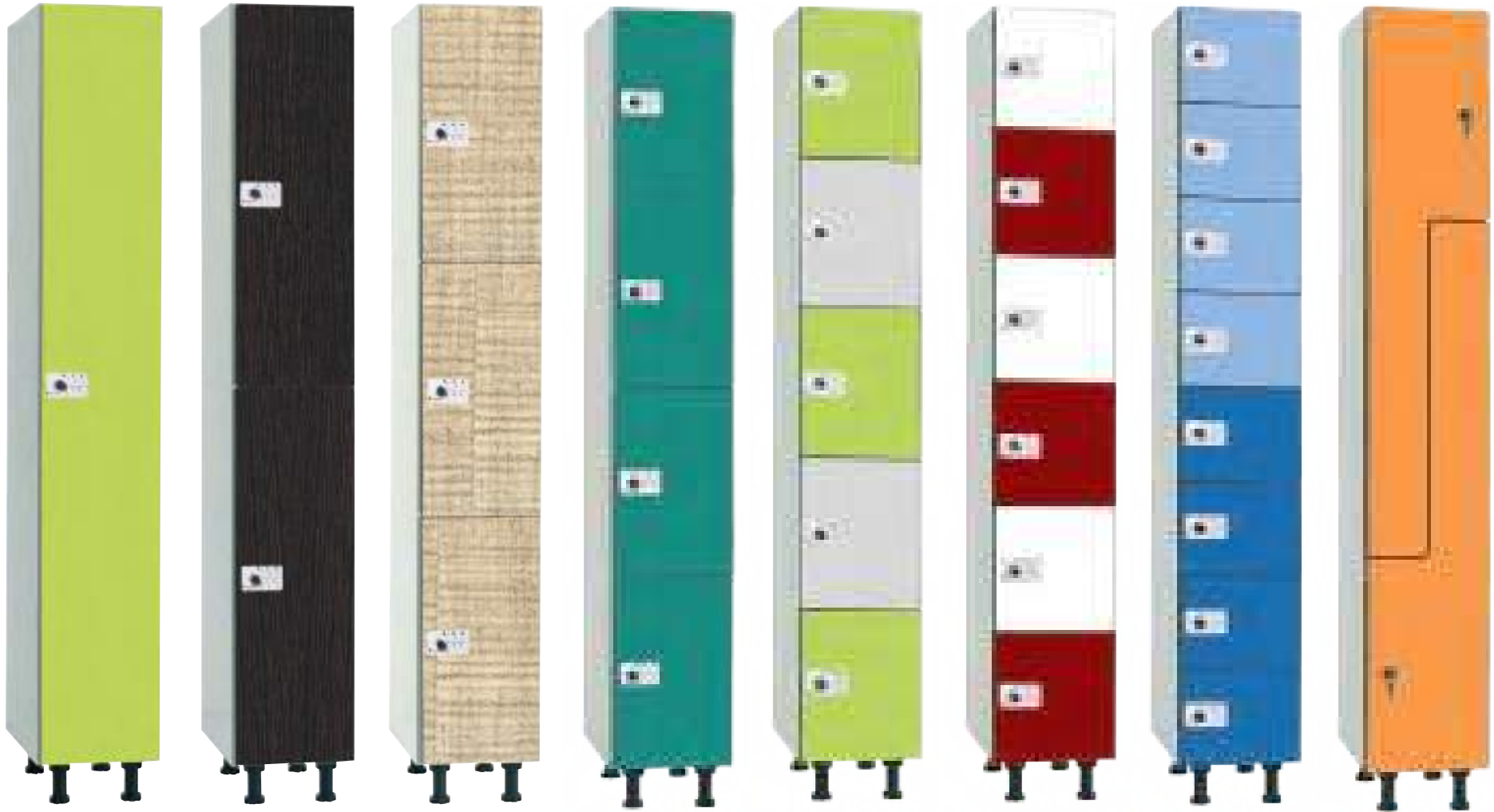

SERIE MHFV

SERIE MHFT

SERIE MHFM

SERIE MHFC

SERIE MHFP

SERIE MHFB

SERIE MHFZ

SERIE MHFL

**COLORES STANDARD PUERTAS / STANDARD DOORS COLOURS / COULEURS PORTES STANDARD / CORES DE PORTAS STANDARD**

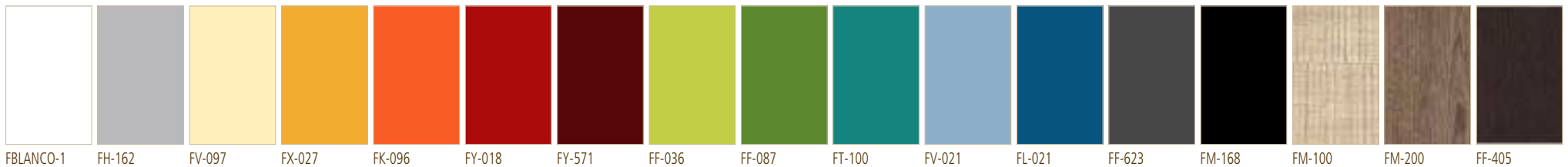

FBLANCO-1 FH-162 FV-097 FX-027 FK-096 FY-018 FY-571 FF-036 FF-087 FT-100 FV-021 FL-021 FF-623 FM-168 FM-100 FM-200 FF-405

OTROS COLORES CONSULTAR / OTHER COLOURS ON REQUEST / AUTRES COULEURS SUR DEMANDE / OUTRAS CORES PERGUNTAR



TAQUILLAS CUERPO MELAMINA HIDRÓFUGA Y PUERTAS FENÓLICAS / LOCKERS WITH BODY IN HYDROPHOBIC MELAMINE AND HPL DOORS / VESTIAIRES CORP EN MÉLAMINÉ HYDROFUGE ET PORTES EN STRATIFIÉ COMPACT / CACIFOS CORPO DE MELAMINA HIDRÓFUGA E PORTAS FENÓLICAS

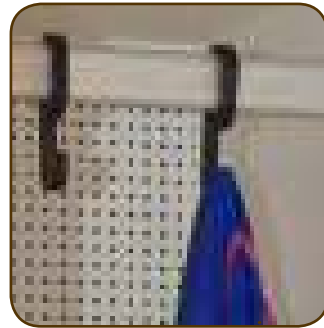

SERIE MHFT

SERIE MHFV



TAQUILLAS CUERPO MELAMINA HIDRÓFUGA Y PUERTAS FENÓLICAS / LOCKERS WITH BODY IN HYDROPHOBIC MELAMINE AND HPL DOORS / VESTIAIRES CORP EN MÉLAMINÉ HYDROFUGE ET PORTES EN STRATIFIÉ COMPACT / CACIFOS CORPO DE MELAMINA HIDRÓFUGA E PORTAS FENÓLICAS

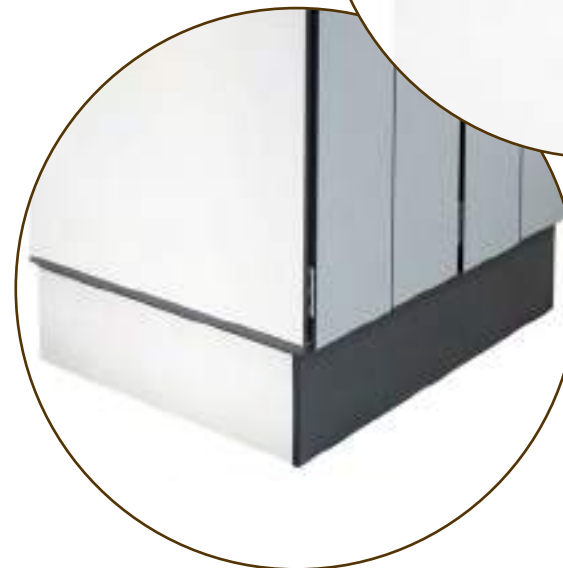
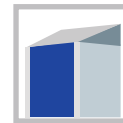
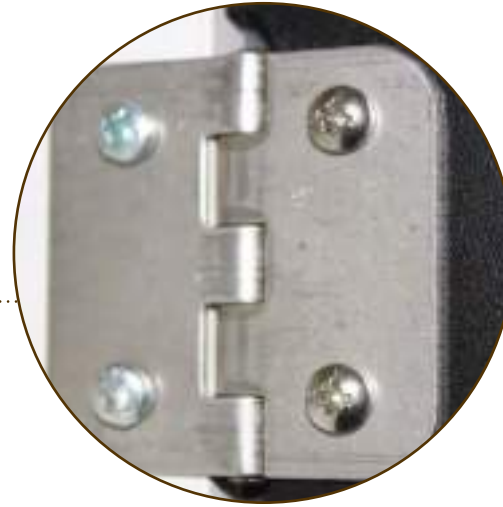

TAQUILLAS CUERPO MELAMINA HIDRÓFUGA Y PUERTAS FENÓLICAS / LOCKERS WITH BODY IN HYDROPHOBIC MELAMINE AND HPL DOORS / VESTIAIRES CORP EN MÉLAMINÉ HYDROFUGE ET PORTES EN STRATIFIÉ COMPACT / CACIFOS CORPO DE MELAMINA HIDRÓFUGA E PORTAS FENÓLICAS

SERIE MHFV

MHFV-30/1 COD. 58501    MHFV-30/2 COD. 58502    MHFV-30/3 COD. 58509    MHFV-30/4 COD. 58601    MHFV-40/1 COD. 58505    MHFV-40/2 COD. 58506    MHFV-40/3 COD. 58602

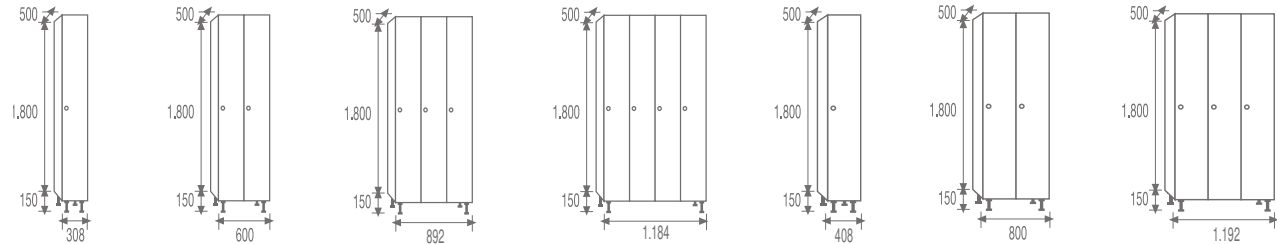

34Kg. • 0,28m<sup>3</sup>    59Kg. • 0,54m<sup>3</sup>    83Kg. • 0,80m<sup>3</sup>    108Kg. • 1,07m<sup>3</sup>    37Kg. • 0,37m<sup>3</sup>    68Kg. • 0,72m<sup>3</sup>    97Kg. • 1,07m<sup>3</sup>

SERIE MHFT

MHFT-30/1 COD. 58511    MHFT-30/2 COD. 58512    MHFT-30/3 COD. 58519    MHFT-30/4 COD. 58605    MHFT-40/1 COD. 58515    MHFT-40/2 COD. 58516    MHFT-40/3 COD. 58606

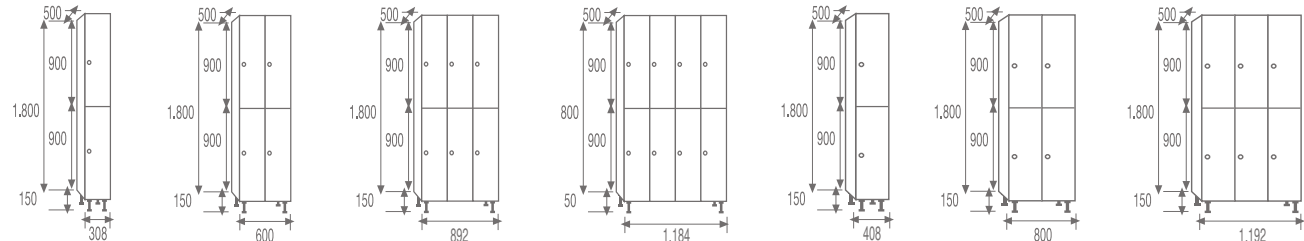

35Kg. • 0,28m<sup>3</sup>    60Kg. • 0,54m<sup>3</sup>    85Kg. • 0,80m<sup>3</sup>    110Kg. • 1,07m<sup>3</sup>    39Kg. • 0,37m<sup>3</sup>    69Kg. • 0,72m<sup>3</sup>    99Kg. • 1,07m<sup>3</sup>

SERIE MHFM

MHFM-30/1 COD. 58531    MHFM-30/2 COD. 58532    MHFM-30/3 COD. 58539    MHFM-30/4 COD. 58609    MHFM-40/1 COD. 58535    MHFM-40/2 COD. 58536    MHFM-40/3 COD. 58610

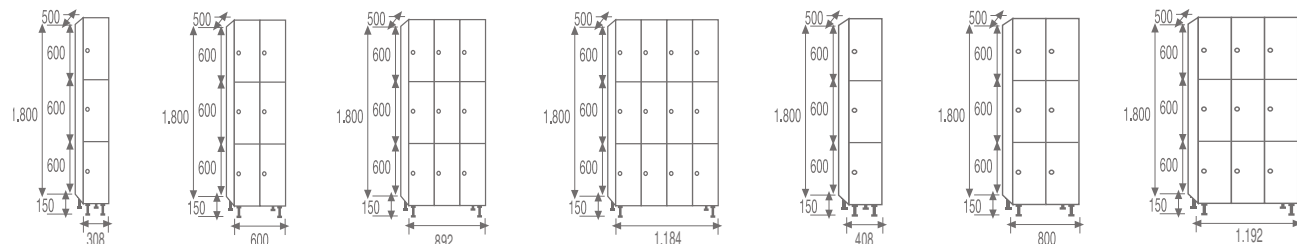

37Kg. • 0,28m<sup>3</sup>    64Kg. • 0,54m<sup>3</sup>    91Kg. • 0,80m<sup>3</sup>    118Kg. • 1,07m<sup>3</sup>    42Kg. • 0,37m<sup>3</sup>    74Kg. • 0,72m<sup>3</sup>    107Kg. • 1,07m<sup>3</sup>

SERIE MHFC

MHFC-30/1 COD. 58521    MHFC-30/2 COD. 58522    MHFC-30/3 COD. 58529    MHFC-30/4 COD. 58613    MHFC-40/1 COD. 58525    MHFC-40/2 COD. 58526    MHFC-40/3 COD. 58614

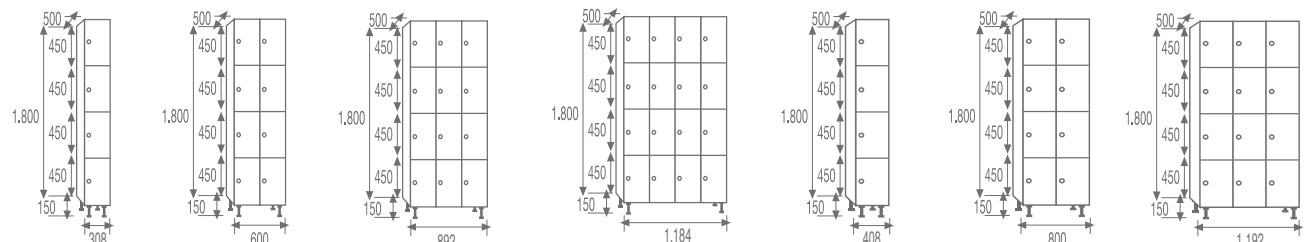

39Kg. • 0,28m<sup>3</sup>    68Kg. • 0,54m<sup>3</sup>    97Kg. • 0,80m<sup>3</sup>    127Kg. • 1,07m<sup>3</sup>    45Kg. • 0,36m<sup>3</sup>    79Kg. • 0,71m<sup>3</sup>    115Kg. • 1,05m<sup>3</sup>

SERIEMHFP

MHFP-30/1 COD. 58551	MHFP-30/2 COD. 58552	MHFP-30/3 COD. 58559	MHFP-30/4 COD. 58617	MHFP-40/1 COD. 58565	MHFP-40/2 COD. 58566	MHFP-40/3 COD. 58618
-------------------------	-------------------------	-------------------------	-------------------------	-------------------------	-------------------------	-------------------------

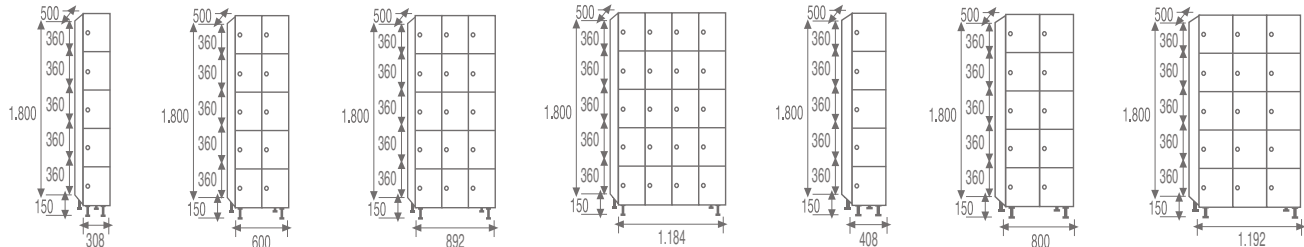

41Kg. • 0,28m <sup>3</sup>	72Kg. • 0,54m <sup>3</sup>	104Kg. • 0,80m <sup>3</sup>	135Kg. • 1,07m <sup>3</sup>	47Kg. • 0,37m <sup>3</sup>	85Kg. • 0,72m <sup>3</sup>	123Kg. • 1,07m <sup>3</sup>
----------------------------	----------------------------	-----------------------------	-----------------------------	----------------------------	----------------------------	-----------------------------

SERIEMHFB

MHFB-30/1 COD. 58561	MHFB-30/2 COD. 58562	MHFB-30/3 COD. 58569	MHFB-30/4 COD. 58621	MHFB-40/1 COD. 58575	MHFB-40/2 COD. 58576	MHFB-40/3 COD. 58622
-------------------------	-------------------------	-------------------------	-------------------------	-------------------------	-------------------------	-------------------------

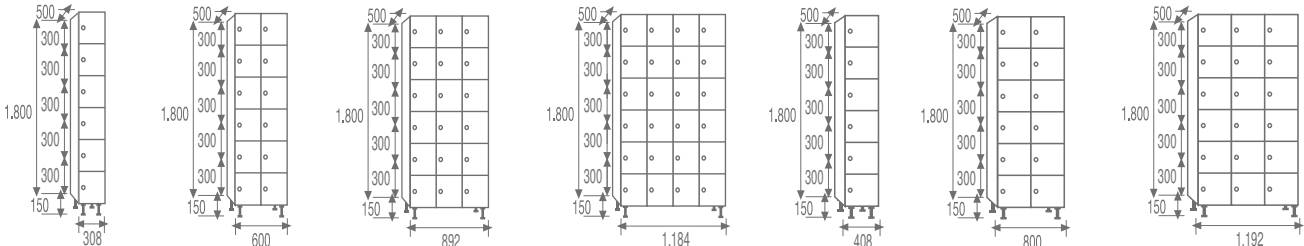

43Kg. • 0,28m <sup>3</sup>	77Kg. • 0,54m <sup>3</sup>	110Kg. • 0,80m <sup>3</sup>	144Kg. • 1,07m <sup>3</sup>	50Kg. • 0,37m <sup>3</sup>	90Kg. • 0,72m <sup>3</sup>	130Kg. • 1,07m <sup>3</sup>
----------------------------	----------------------------	-----------------------------	-----------------------------	----------------------------	----------------------------	-----------------------------

SERIEMHFZ

MHFZ-30/1 COD. 58581	MHFZ-30/2 COD. 58582	MHFZ-30/3 COD. 58589	MHFZ-30/4 COD. 58625	MHFZ-40/1 COD. 58585	MHFZ-40/2 COD. 58586	MHFZ-40/3 COD. 58626
-------------------------	-------------------------	-------------------------	-------------------------	-------------------------	-------------------------	-------------------------

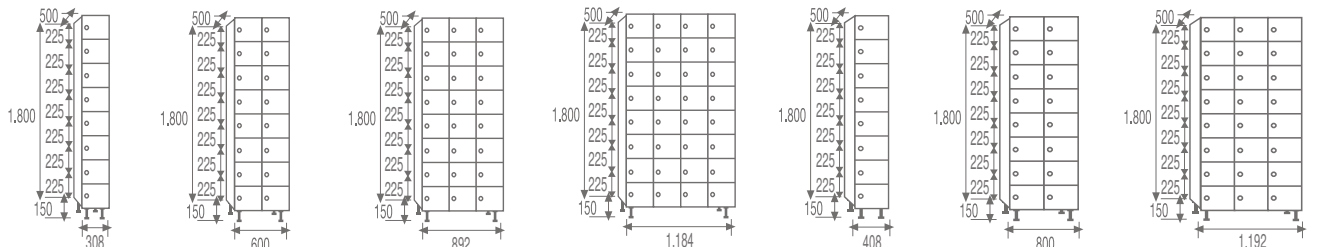

47Kg. • 0,28m <sup>3</sup>	85Kg. • 0,54m <sup>3</sup>	123Kg. • 0,80m <sup>3</sup>	160Kg. • 1,07m <sup>3</sup>	55Kg. • 0,37m <sup>3</sup>	100Kg. • 0,72m <sup>3</sup>	146Kg. • 1,07m <sup>3</sup>
----------------------------	----------------------------	-----------------------------	-----------------------------	----------------------------	-----------------------------	-----------------------------

SERIEMHFL

MHFL-30/1 COD. 58541	MHFL-30/2 COD. 58542	MHFL-30/3 COD. 58549	MHFL-30/4 COD. 58629	MHFL-40/1 COD. 58545	MHFL-40/2 COD. 58546	MHFL-40/3 COD. 58630
-------------------------	-------------------------	-------------------------	-------------------------	-------------------------	-------------------------	-------------------------

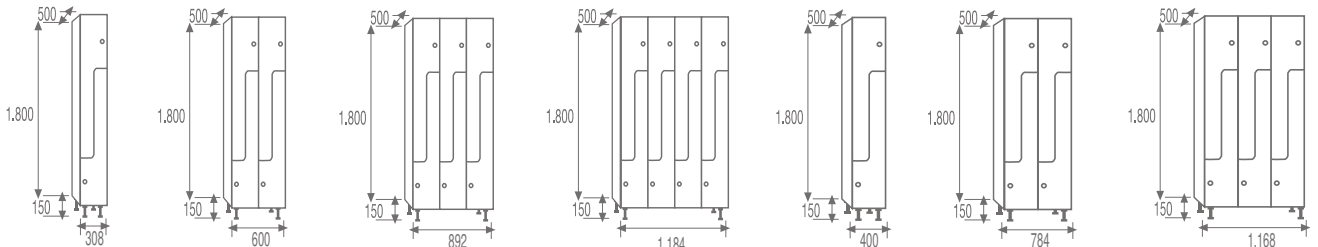

40Kg. • 0,28m <sup>3</sup>	69Kg. • 0,54m <sup>3</sup>	99Kg. • 0,80m <sup>3</sup>	129Kg. • 1,07m <sup>3</sup>	44Kg. • 0,36m <sup>3</sup>	79Kg. • 0,71m <sup>3</sup>	113Kg. • 1,05m <sup>3</sup>
----------------------------	----------------------------	----------------------------	-----------------------------	----------------------------	----------------------------	-----------------------------









# TAQUILLAS CUERPO EN COMPACMEL PLUS Y PUERTAS FENÓLICAS

LOCKERS WITH BODY IN COMPACMEL PLUS AND HPL DOORS

VESTIAIRES CORP EN COMPACMEL PLUS ET PORTES EN STRATIFIÉ

CACIFOS CORPO DE COMPACMEL PLUS E PORTAS FENÓLICAS

CARACTERÍSTICAS / CHARACTERISTICS / CARACTERISTIQUES / CARACTERISTICAS



Tornillería y bisagras en acero inoxidable.  
Screws and hinges in stainless steel.  
Vis et charnières en acier inoxydable.  
Parafusos e dobradiças em aço inox.

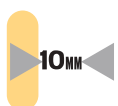

Espesores.  
Thicknesses.  
Épaisseurs.  
Espessura.



Pata regulable en altura.  
Legs adjustable in height.  
Pieds réglables en hauteur.  
Pés reguláveis em altura.

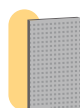

Trasera en tablero perforado y totalmente enmarcada.  
Back panel made of perforated tablex and totally framed.  
Partie arrière en tablex perforé et totalement encadrée.  
Parte de atrás construída em tablero perforado e totalmente encaixada.



Placa de numeración incluida.  
Numeration plate included.  
Plaque numérique inclus.  
Placa de numeração inclusa.



Cantos redondeados.  
Rounded edges.  
Sans arête vive.  
Cantos arredondados.

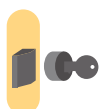

Cerradura de resbalón con bombillo extraíble y llave maestra.  
Latch operated lock with removable cylinder and master key.  
Serrure à plaquer avec cylindre enlevable et clé passe.  
Fechadura de segurança com possibilidade de tirar o cilindro e chave mestre.



Cuerpo.  
Body.  
Corps.  
Corpo.



Gran resistencia.  
Great resistance.  
Très résistant.  
Muito resistente.



Recomendado para ambientes húmedos. Resistente al agua. Waterproof.  
Recommended for wet areas. Waterproof.  
Recommandé pour les environnements humides.  
Recomendado para lugares com humidade. Resistente a água.



Fácil limpieza.  
Easy cleaning.  
Nettoyage facile.  
Fácil limpeza.

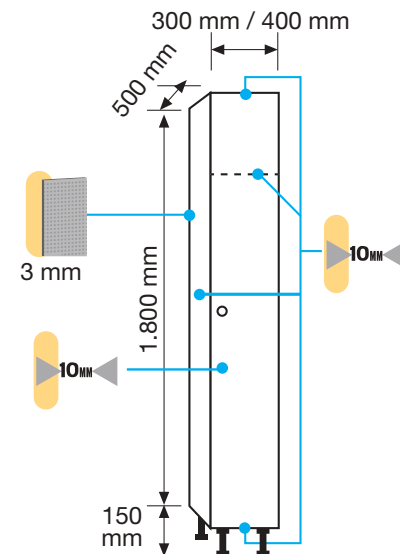

OPCIONES / OPTIONS / OPTIONS / OPÇÕES

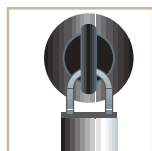

Pomo en poliamida (candado opcional)  
Padlockable Polyamide Lock (optional padlock)  
Poignée cadénassable en polyamide (cadenas en option)  
Fechadura de cadeado em poliamida



Pomo metálico (candado combinación opcional)  
Padlockable Metallic Lock (optional combination padlock)  
Poignée métallique (cadenas à combinaison en option)  
Fechadura de cadeado em metal



Monedero (moneda retornable).  
Coin-operated Lock (coin-return).  
Monnayeur (monnaie réversible).  
Moedeiro (moeda retornável).

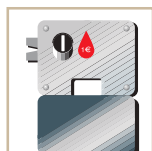

Monedero + cajetín depósito.  
Coin-operated Lock + Coin Collect Box (cash box, non coin-return).  
Monnayeur + tirelire (monnaie non réversible).  
Moedeiro + caixinha para as moedas.



Cerradura electrónica de combinación de 4 dígitos.  
Electronic lock combination of 4 digits.  
Serrure électronique à combinaison de 4 chiffres.  
Fechadura electrónica, combinação de 4 dígitos.



Cerradura de proximidad  
Lock of proximity  
Serrure de proximité  
Fechadura de proximidade



Cerradura electrónica de combinación de 4 dígitos.  
Electronic lock combination of 4 digits.  
Serrure électronique à combinaison de 4 chiffres.  
Fechadura electrónica, combinação de 4 dígitos.



Cerradura electrónica de combinación de 4 dígitos.  
Electronic lock combination of 4 digits.  
Serrure électronique à combinaison de 4 chiffres.  
Fechadura electrónica, combinação de 4 dígitos.



Cerradura de proximidad  
Lock of proximity  
Serrure de proximité  
Fechadura de proximidade



Cerradura de proximidad  
Lock of proximity  
Serrure de proximité  
Fechadura de proximidade



Cerradura de combinación y llave de emergencia  
Lock of 4 manual digits with emergency key  
Serrure à combinaison et clef de émergence  
Fechadura de combinação e chave de emergência



Cerradura electrónica de combinación de 4 dígitos.  
Electronic lock combination of 4 digits.  
Serrure électronique à combinaison de 4 chiffres.  
Fechadura electrónica, combinação de 4 dígitos.



Cerradura electrónica de combinación de 4 dígitos.  
Electronic lock combination of 4 digits.  
Serrure électronique à combinaison de 4 chiffres.  
Fechadura electrónica, combinação de 4 dígitos.



Bisagra a 180°  
180° hinge opening  
Charnière a 180°  
Dobradiça a 180°

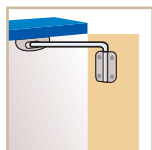

Retenedor de puerta a 90°  
Door opening limiter 90°  
Entrebâilleur de porte à 90 degrés  
Retenedor para porta a 90 graus



Zócalo melamina  
Melamine Socle  
Mélamine Socle  
Base de melamina



Lateral embellecedor  
Decorative end panel  
Enjoliveur latéral  
Lateral de feição

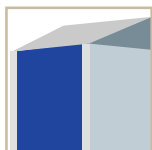

Sobretecho inclinado  
Slope Top  
Toit incliné  
Sobreteito com pequena inclinação



Cierre para candado  
Closing for padlock  
Fermeture pour cadenas  
Fechadura para cadeado

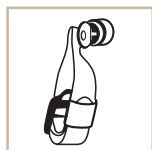

Pulsera de nylon  
Bracelet of nylon  
Bracelet en nylon  
Pulseira de náilon



Pulsera elástica  
Elastic Bracelet  
Bracelet élastique  
Pulseira elástica



SERIE CV

SERIE CT

SERIE CM

SERIE CC

SERIE CP

SERIE CB

SERIE CZ

SERIE CL

**COLORES STANDARD PUERTAS / STANDARD DOORS COLOURS / COULEURS PORTES STANDARD / CORES DE PORTAS STANDARD**



FBLANCO-1 FH-162 FV-097 FX-027 FK-096 FY-018 FY-571 FF-036 FF-087 FT-100 FV-021 FL-021 FF-623 FM-168 FM-100 FM-200 FF-405

OTROS COLORES CONSULTAR / OTHER COLOURS ON REQUEST / AUTRES COULEURS SUR DEMANDE / OUTRAS CORES PERGUNTAR

TAQUILLAS CUERPO EN COMPACMEL PLUS Y PUERTAS FENÓLICAS / LOCKERS WITH BODY IN COMPACMEL PLUS AND HPL DOORS / VESTIAIRES CORP EN COMPACMEL PLUS ET PORTES EN STRATIFIÉ / CACIFOS CORPO DE COMPACMEL PLUS E PORTAS FENÓLICAS









TAQUILLAS CUERPO EN COMPACMEL PLUS Y PUERTAS FENÓLICAS / LOCKERS WITH BODY IN COMPACMEL PLUS AND HPL DOORS / VESTIAIRES CORP EN COMPACMEL PLUS ET PORTES EN STRATIFIÉ / CACIFOS CORPO DE COMPACMEL PLUS E PORTAS FENÓLICAS

SERIE CV

CV-30/1 COD. 54001	CV-30/2 COD. 54101	CV-30/3 COD. 54102	CV-30/4 COD. 54103	CV-40/1 COD. 54002	CV-40/2 COD. 54112	CV-40/3 COD. 54113
44Kg. • 0,27m <sup>3</sup>	75Kg. • 0,54m <sup>3</sup>	105Kg. • 0,81m <sup>3</sup>	135Kg. • 1,07m <sup>3</sup>	49Kg. • 0,36m <sup>3</sup>	85Kg. • 0,71m <sup>3</sup>	121Kg. • 1,06m <sup>3</sup>

SERIE CT

CT-30/1 COD. 54011	CT-30/2 COD. 54120	CT-30/3 COD. 54121	CT-30/4 COD. 54122	CT-40/1 COD. 54012	CT-40/2 COD. 54123	CT-40/3 COD. 54124
45Kg. • 0,27m <sup>3</sup>	76Kg. • 0,54m <sup>3</sup>	106Kg. • 0,81m <sup>3</sup>	137Kg. • 1,07m <sup>3</sup>	50Kg. • 0,36m <sup>3</sup>	86Kg. • 0,71m <sup>3</sup>	123Kg. • 1,06m <sup>3</sup>

SERIE CM

CM-30/1 COD. 54031	CM-30/2 COD. 54131	CM-30/3 COD. 54132	CM-30/4 COD. 54133	CM-40/1 COD. 54032	CM-40/2 COD. 54134	CM-40/3 COD. 54135
47Kg. • 0,27m <sup>3</sup>	80Kg. • 0,54m <sup>3</sup>	114Kg. • 0,81m <sup>3</sup>	148Kg. • 1,07m <sup>3</sup>	53Kg. • 0,36m <sup>3</sup>	93Kg. • 0,71m <sup>3</sup>	133Kg. • 1,06m <sup>3</sup>

SERIE CC

CC-30/1 COD. 54021	CC-30/2 COD. 54141	CC-30/3 COD. 54142	CC-30/4 COD. 54143	CC-40/1 COD. 54022	CC-40/2 COD. 54144	CC-40/3 COD. 54145
50Kg. • 0,27m <sup>3</sup>	86Kg. • 0,54m <sup>3</sup>	122Kg. • 0,81m <sup>3</sup>	158Kg. • 1,07m <sup>3</sup>	56Kg. • 0,36m <sup>3</sup>	99Kg. • 0,71m <sup>3</sup>	143Kg. • 1,06m <sup>3</sup>

SERIE CP

CP-30/1 COD. 54051	CP-30/2 COD. 54151	CP-30/3 COD. 54152	CP-30/4 COD. 54153	CP-40/1 COD. 54052	CP-40/2 COD. 54154	CP-40/3 COD. 54155
52Kg. • 0,27m <sup>3</sup>	91Kg. • 0,54m <sup>3</sup>	130Kg. • 0,81m <sup>3</sup>	169Kg. • 1,07m <sup>3</sup>	60Kg. • 0,36m <sup>3</sup>	106Kg. • 0,71m <sup>3</sup>	153Kg. • 1,06m <sup>3</sup>

SERIE CB

CB-30/1 COD. 54061	CB-30/2 COD. 54161	CB-30/3 COD. 54162	CB-30/4 COD. 54163	CB-40/1 COD. 54062	CB-40/2 COD. 54164	CB-40/3 COD. 54165
55Kg. • 0,27m <sup>3</sup>	96Kg. • 0,54m <sup>3</sup>	138Kg. • 0,81m <sup>3</sup>	180Kg. • 1,07m <sup>3</sup>	63Kg. • 0,36m <sup>3</sup>	113Kg. • 0,71m <sup>3</sup>	164Kg. • 1,06m <sup>3</sup>

SERIE CZ

CZ-30/1 COD. 54081	CZ-30/2 COD. 54171	CZ-30/3 COD. 54172	CZ-30/4 COD. 54173	CZ-40/1 COD. 54082	CZ-40/2 COD. 54174	CZ-40/3 COD. 54175
60Kg. • 0,27m <sup>3</sup>	107Kg. • 0,54m <sup>3</sup>	154Kg. • 0,81m <sup>3</sup>	201Kg. • 1,07m <sup>3</sup>	70Kg. • 0,36m <sup>3</sup>	127Kg. • 0,71m <sup>3</sup>	184Kg. • 1,06m <sup>3</sup>

SERIE CL

CL-30/1 COD. 54041	CL-30/2 COD. 54181	CL-30/3 COD. 54182	CL-30/4 COD. 54183	CL-40/1 COD. 54042	CL-40/2 COD. 54184	CL-40/3 COD. 54185
51Kg. • 0,27m <sup>3</sup>	92Kg. • 0,54m <sup>3</sup>	134Kg. • 0,81m <sup>3</sup>	175Kg. • 1,07m <sup>3</sup>	56Kg. • 0,36m <sup>3</sup>	103Kg. • 0,71m <sup>3</sup>	160Kg. • 1,06m <sup>3</sup>



SALIDA

26 27 28 29 30 31 32 33 34 35 36 37 38 39

64 65 66 67 68 69 70 71 72 73 74 75 76 77 78



# TAQUILLAS FENÓLICAS CON PERFILERÍA

PHENOLIC LOCKERS WITH ALUMINIUM PROFILE

VESTIAIRES EN STRATIFIÉ AVEC PROFILÉS

CACIFOS DE RESINAS FENÓLICAS COM PERFILARIA DE ALUMÍNIO

CARACTERÍSTICAS / CHARACTERISTICS / CARACTERISTIQUES / CARACTERISTICAS



Tornillería y bisagras en acero inoxidable.  
Screws and hinges in stainless steel.  
Vis et charnières en acier inoxydable.  
Parafusos e dobradiças em aço inox.

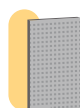

Trasera en tablex perforado y totalmente enmarcada.  
Back panel made of perforated tablex and totally framed.  
Partie arrière en tablex perforé et totalement encadrée.  
Parte de atrás construída em tablex perfurado e totalmente encaixada.



Cerradura de resbalón con bombillo extraíble y llave maestra.  
Latch operated lock with removable cylinder and master key.  
Serrure à plaquer avec cylindre enlevable et clé passe.  
Fechadura de segurança com possibilidade de tirar o cilindro e chave mestre.



Fácil limpieza.  
Easy cleaning.  
Nettoyage facile.  
Fácil limpeza.

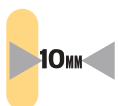

Espesores.  
Thicknesses.  
Épaisseurs.  
Espessura.



Placa de numeración incluida.  
Numeration plate included.  
Plaque numérique inclus.  
Placa de numeração inclusa.



Cuerpo.  
Body.  
Corps.  
Corpo.



Material de gran resistencia, hidrófugo, ignífugo y antibacteriano.  
Material of great resistance, hydrophobic, fire resistant and antibacterial.  
Matériel très résistant, hydrofuge, ignifuge et antibactérien.  
Material muito resistente, hidrófugo, ignífugo e antibacteriano.



Pata regulable en altura.  
Legs adjustable in height.  
Pieds réglables en hauteur.  
Pés reguláveis em altura.



Cantos redondeados.  
Rounded edges.  
Sans arête vive.  
Cantos arredondados.



Gran resistencia.  
Great resistance.  
Très résistant.  
Muito resistente.

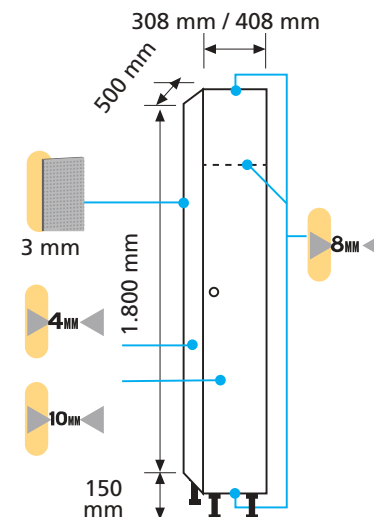

OPCIONES / OPTIONS / OPTIONS / OPÇÕES

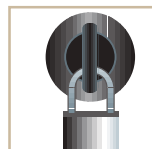

Pomo en poliamida (candado opcional)  
Padlockable Polyamide Lock (optional padlock)  
Poignée cadénassable en polyamide (cadenas en option)  
Fechadura de cadeado em poliamida



Pomo metálico (candado combinación opcional)  
Padlockable Metallic Lock (optional combination padlock)  
Poignée métallique (cadenas à combinaison en option)  
Fechadura de cadeado em metal



Monedero (moneda retornable).  
Coin-operated Lock (coin-return).  
Monnayeur (monnaie réversible).  
Moedeiro (moeda retornável).



Monedero + cajetín depósito.  
Coin-operated Lock + Coin Collect Box (cash box, non coin-return).  
Monnayeur + tirelire (monnaie non réversible).  
Moedeiro + caixinha para as moedas.



Cerradura electrónica de combinación de 4 dígitos.  
Electronic lock combination of 4 digits.  
Serrure électronique à combinaison de 4 chiffres.  
Fechadura electrónica, combinação de 4 dígitos.



Cerradura de proximidad  
Lock of proximity  
Serrure de proximité  
Fechadura de proximidade



Cerradura electrónica de combinación de 4 dígitos.  
Electronic lock combination of 4 digits.  
Serrure électronique à combinaison de 4 chiffres.  
Fechadura electrónica, combinação de 4 dígitos.



Cerradura electrónica de combinación de 4 dígitos.  
Electronic lock combination of 4 digits.  
Serrure électronique à combinaison de 4 chiffres.  
Fechadura electrónica, combinação de 4 dígitos.



Cerradura de proximidad  
Lock of proximity  
Serrure de proximité  
Fechadura de proximidade



Cerradura de proximidad  
Lock of proximity  
Serrure de proximité  
Fechadura de proximidade



Cerradura de combinación y llave de emergencia  
Lock of 4 manual digits with emergency key  
Serrure à combinaison et clef de émergence  
Fechadura de combinação e chave de emergência



Cerradura electrónica de combinación de 4 dígitos.  
Electronic lock combination of 4 digits.  
Serrure électronique à combinaison de 4 chiffres.  
Fechadura electrónica, combinação de 4 dígitos.



Cerradura electrónica de combinación de 4 dígitos.  
Electronic lock combination of 4 digits.  
Serrure électronique à combinaison de 4 chiffres.  
Fechadura electrónica, combinação de 4 dígitos.



Bisagra a 180°  
180° hinge opening  
Charnière a 180°  
Dobradiça a 180°

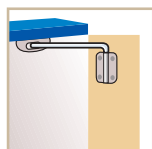

Retenedor de puerta a 90°  
Door opening limiter 90°  
Entrebâilleur de porte à 90 degrés  
Retentor para porta a 90 graus



Zócalo melamina  
Melamine Socle  
Mélamine Socle  
Base de melamina



Lateral embellecedor  
Decorative end panel  
Enjoliveur latéral  
Lateral de finishing

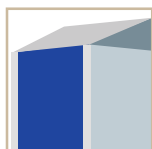

Sobreteto inclinado  
Slope Top  
Toit incliné  
Sobreteto com pequena inclinação



Cierre para candado  
Closing for padlock  
Fermeture pour cadenas  
Fechadura para cadeado

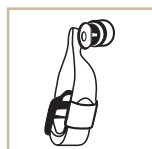

Pulsera de nylon  
Bracelet of nylon  
Bracelet en nylon  
Pulseira de náilon



Pulsera elástica  
Elastic Bracelet  
Bracelet élastique  
Pulseira elástica





SERIE FVP

SERIE FTP

SERIE FMP

SERIE FCP

SERIE FPP

SERIE FBP

SERIE FZP

SERIE FLP

**COLORES STANDARD PUERTAS / STANDARD DOORS COLOURS / COULEURS PORTES STANDARD / CORES DE PORTAS STANDARD**



FBLANCO-1

FH-162

FV-097

FX-027

FK-096

FY-018

FY-571

FF-036

FF-087

FT-100

FV-021

FL-021

FF-623

FM-168

FM-100

FM-200

FF-405

OTROS COLORES CONSULTAR / OTHER COLOURS ON REQUEST / AUTRES COULEURS SUR DEMANDE / OUTRAS CORES PERGUNTAR

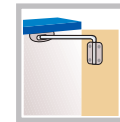



TAQUILLAS FENÓLICAS CON PERFILERÍA / PHENOLIC LOCKERS WITH ALUMINIUM PROFILE /  
 VESTIAIRES EN STRATIFIE AVEC PROFILS / CACIFOS DE RESINAS FENÓLICAS COM PERFILARIA DE ALUMÍNIO

SERIE FVP

FVP-30/1 COD. 53501    FVP-30/2 COD. 53502    FVP-30/3 COD. 53509    FVP-30/4 COD. 53601    FVP-40/1 COD. 53505    FVP-40/2 COD. 53506    FVP-40/3 COD. 53602

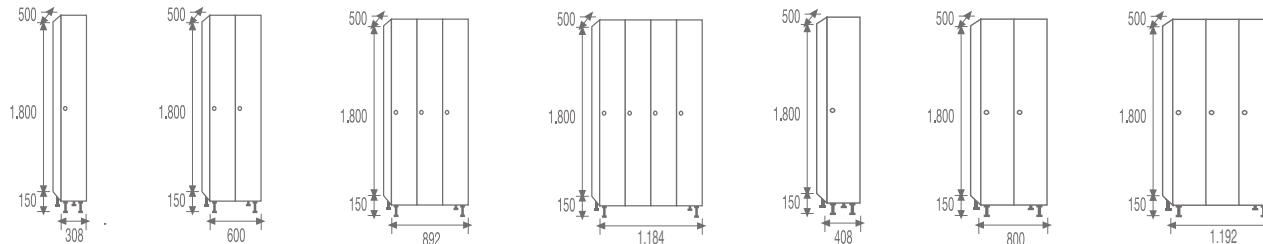

31Kg. • 0,28m<sup>3</sup>    55Kg. • 0,54m<sup>3</sup>    79Kg. • 0,80m<sup>3</sup>    104Kg. • 1,07m<sup>3</sup>    37Kg. • 0,37m<sup>3</sup>    66Kg. • 0,72m<sup>3</sup>    96Kg. • 1,07m<sup>3</sup>

SERIE FTP

FTP-30/1 COD. 53511    FTP-30/2 COD. 53512    FTP-30/3 COD. 53519    FTP-30/4 COD. 53605    FTP-40/1 COD. 53515    FTP-40/2 COD. 53516    FTP-40/3 COD. 53606

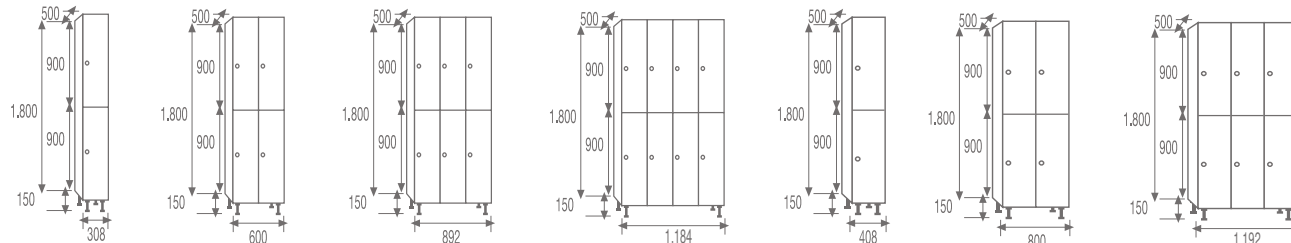

32Kg. • 0,28m<sup>3</sup>    56Kg. • 0,54m<sup>3</sup>    81Kg. • 0,80m<sup>3</sup>    106Kg. • 1,07m<sup>3</sup>    37Kg. • 0,37m<sup>3</sup>    67Kg. • 0,72m<sup>3</sup>    97Kg. • 1,07m<sup>3</sup>

SERIE FMP

FMP-30/1 COD. 53531    FMP-30/2 COD. 53532    FMP-30/3 COD. 53539    FMP-30/4 COD. 53609    FMP-40/1 COD. 53535    FMP-40/2 COD. 53536    FMP-40/3 COD. 53610

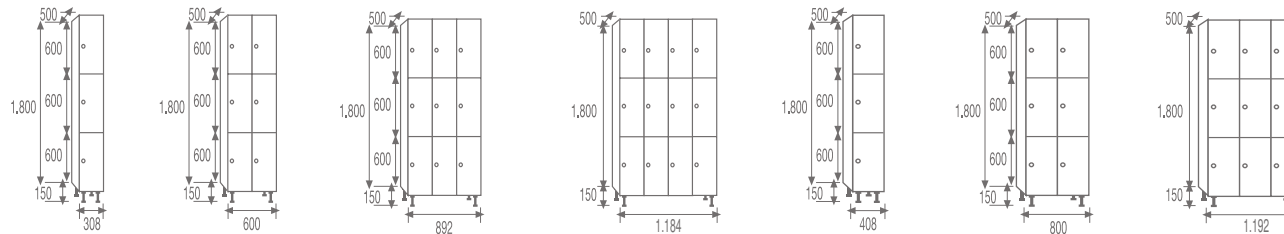

34Kg. • 0,28m<sup>3</sup>    62Kg. • 0,54m<sup>3</sup>    89Kg. • 0,80m<sup>3</sup>    116Kg. • 1,07m<sup>3</sup>    40Kg. • 0,37m<sup>3</sup>    74Kg. • 0,72m<sup>3</sup>    108Kg. • 1,07m<sup>3</sup>

SERIE FCP

FCP-30/1 COD. 53521    FCP-30/2 COD. 53522    FCP-30/3 COD. 53529    FCP-30/4 COD. 53613    FCP-40/1 COD. 53525    FCP-40/2 COD. 53526    FCP-40/3 COD. 53614

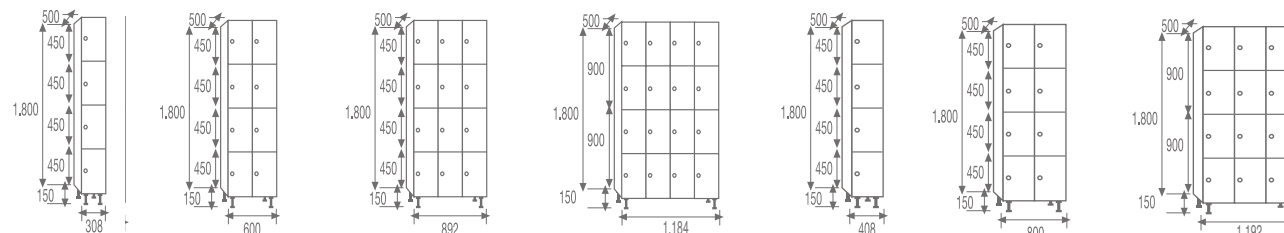

37Kg. • 0,28m<sup>3</sup>    67Kg. • 0,54m<sup>3</sup>    97Kg. • 0,80m<sup>3</sup>    127Kg. • 1,07m<sup>3</sup>    44Kg. • 0,37m<sup>3</sup>    81Kg. • 0,72m<sup>3</sup>    118Kg. • 1,07m<sup>3</sup>

TAQUILLAS FENÓLICAS CON PERFILERÍA / PHENOLIC LOCKERS WITH ALUMINIUM PROFILE /  
 VESTIAIRES EN STRATIFIE AVEC PROFILS / CACIFOS DE RESINAS FENÓLICAS COM PERFILARIA DE ALUMÍNIO

SERIE FPP

FPP-30/1 COD. 53551	FPP-30/2 COD. 53552	FPP-30/3 COD. 53559	FPP-30/4 COD. 53617	FPP-40/1 COD. 53565	FPP-40/2 COD. 53566	FPP-40/3 COD. 53618
40Kg. • 0,28m <sup>3</sup>	73Kg. • 0,54m <sup>3</sup>	105Kg. • 0,80m <sup>3</sup>	138Kg. • 1,07m <sup>3</sup>	47Kg. • 0,37m <sup>3</sup>	88Kg. • 0,72m <sup>3</sup>	128Kg. • 1,07m <sup>3</sup>

SERIE FBP

FBP-30/1 COD. 53561	FBP-30/2 COD. 53562	FBP-30/3 COD. 53569	FBP-30/4 COD. 53621	FBP-40/1 COD. 53575	FBP-40/2 COD. 53576	FBP-40/3 COD. 53622
42Kg. • 0,28m <sup>3</sup>	78Kg. • 0,54m <sup>3</sup>	113Kg. • 0,80m <sup>3</sup>	149Kg. • 1,07m <sup>3</sup>	51Kg. • 0,37m <sup>3</sup>	94Kg. • 0,72m <sup>3</sup>	139Kg. • 1,07m <sup>3</sup>

SERIE FZP

FZP-30/1 COD. 53581	FZP-30/2 COD. 53582	FZP-30/3 COD. 53589	FZP-30/4 COD. 53625	FZP-40/1 COD. 53585	FZP-40/2 COD. 53586	FZP-40/3 COD. 53626
48Kg. • 0,28m <sup>3</sup>	89Kg. • 0,54m <sup>3</sup>	129Kg. • 0,80m <sup>3</sup>	170Kg. • 1,07m <sup>3</sup>	57Kg. • 0,37m <sup>3</sup>	108Kg. • 0,72m <sup>3</sup>	159Kg. • 1,07m <sup>3</sup>

SERIE FLP

FLP-30/1 COD. 53541	FLP-30/2 COD. 53542	FLP-30/3 COD. 53549	FLP-30/4 COD. 53629	FLP-40/1 COD. 53545	FLP-40/2 COD. 53546	FLP-40/3 COD. 53630
38Kg. • 0,28m <sup>3</sup>	70Kg. • 0,54m <sup>3</sup>	101Kg. • 0,80m <sup>3</sup>	132Kg. • 1,07m <sup>3</sup>	44Kg. • 0,36m <sup>3</sup>	80Kg. • 0,71m <sup>3</sup>	117Kg. • 1,05m <sup>3</sup>







TAQUILLAS FENÓLICAS

PHENOLIC LOCKERS

VESTIAIRES EN STRATIFIÉ

CACIFOS DE RESINAS FENÓLICAS

## CARACTERÍSTICAS / CHARACTERISTICS / CARACTERISTIQUES / CARACTERISTICAS



Tornillería y bisagras en acero inoxidable.  
Screws and hinges in stainless steel.  
Vis et charnières en acier inoxydable.  
Parafusos e dobradiças em aço inox.



Espesores.  
Thicknesses.  
Épaisseurs.  
Espessura.



Pata regulable en altura.  
Legs adjustable in height.  
Pieds réglables en hauteur.  
Pés reguláveis em altura.



Trasera en tablex perforado y totalmente enmarcada.  
Back panel made of perforated tablex and totally framed.  
Partie arrière en tablex perforé et totalement encadrée.  
Parte de atrás construída em tablex perfurado e totalmente encaixada.



Cantos redondeados.  
Rounded edges.  
Sans arête vive.  
Cantos redondeados.



Placa de numeración incluida.  
Numeration plate included.  
Plaque numérique inclus.  
Placa de numeração inclusa.



Recomendado para ambientes húmedos. Resistente al agua. Waterproof.  
Recommended for wet areas. Waterproof.  
Récommandé pour les environnements humides.  
Recomendado para lugares com humidade. Resistente a água.



Cuerpo.  
Body.  
Corps.  
Corpo.



Gran resistencia.  
Great resistance.  
Très résistant.  
Muito resistente.



Cerradura de resbalón con bombillo extraíble y llave maestra.  
Latch operated lock with removable cylinder and master key.  
Serrure à plaquer avec cylindre enlevable et clé passe.  
Fechadura de segurança com possibilidade de tirar o cilindro e chave mestre.



Fácil limpieza.  
Easy cleaning.  
Nettoyage facile.  
Fácil limpeza.



Material de gran resistencia, hidrófugo, ignífugo y antibacteriano.  
Material of great resistance, hydrophobic, fire resistant and antibacterial.  
Matériel très résistant, hydrofuge, ignifuge et antibactérien.  
Material muito resistente, hidrófugo, ignífugo e antibacteriano.

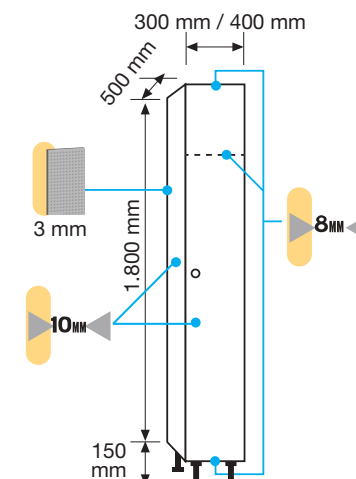

## OPCIONES / OPTIONS / OPTIONS / OPÇÕES

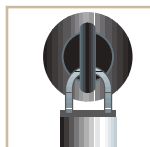

Pomo en poliamida (candado opcional)  
Padlockable Polyamide Lock (optional padlock)  
Poignée cadenassable en polyamide (cadenas en option)  
Fechadura de cadeado em poliamida



Pomo metálico (candado combinación opcional)  
Padlockable Metallic Lock (optional combination padlock)  
Poignée métallique (cadenas à combinaison en option)  
Fechadura de cadeado em metal



Monedero (moneda retornable).  
Coin-operated Lock (coin-return).  
Monnayeur (monnaie réversible).  
Moedeiro (moeda retornável).

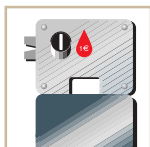

Monedero + cajetín depósito.  
Coin-operated Lock + Coin Collect Box (cash box, non coin-return).  
Monnayeur + tirelire (monnaie non réversible).  
Moedeiro + caixinha para as moedas.



Cerradura electrónica de combinación de 4 dígitos.  
Electronic lock combination of 4 digits.  
Serrure électronique à combinaison de 4 chiffres.  
Fechadura electrónica, combinação de 4 dígitos.



Cerradura de proximidad  
Lock of proximity  
Serrure de proximité  
Fechadura de proximidade



Cerradura electrónica de combinación de 4 dígitos.  
Electronic lock combination of 4 digits.  
Serrure électronique à combinaison de 4 chiffres.  
Fechadura electrónica, combinação de 4 dígitos.



Cerradura electrónica de combinación de 4 dígitos.  
Electronic lock combination of 4 digits.  
Serrure électronique à combinaison de 4 chiffres.  
Fechadura electrónica, combinação de 4 dígitos.



Cerradura de proximidad  
Lock of proximity  
Serrure de proximité  
Fechadura de proximidade



Cerradura de proximidad  
Lock of proximity  
Serrure de proximité  
Fechadura de proximidade



Cerradura de combinación y llave de emergencia  
Lock of 4 manual digits with emergency key  
Serrure à combinaison et clef de émergence  
Fechadura de combinação e chave de emergência



Cerradura electrónica de combinación de 4 dígitos.  
Electronic lock combination of 4 digits.  
Serrure électronique à combinaison de 4 chiffres.  
Fechadura electrónica, combinação de 4 dígitos.



Cerradura electrónica de combinación de 4 dígitos.  
Electronic lock combination of 4 digits.  
Serrure électronique à combinaison de 4 chiffres.  
Fechadura electrónica, combinação de 4 dígitos.



Bisagra a 180°  
180° hinge opening  
Charnière a 180°  
Dobradiça a 180°

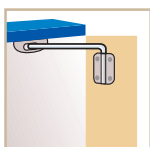

Retenedor de puerta a 90°  
Door opening limiter 90°  
Entrebaïlleur de porte à 90 degrés  
Retentor para porta a 90 graus



Zócalo melamina  
Melamine Socle  
Mélamine Socle  
Base de melamina



Lateral embellecedor  
Decorative end panel  
Enjoliveur latéral  
Lateral de feitura

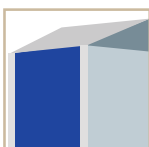

Sobreteto inclinado  
Slope Top  
Toit incliné  
Sobreteto com pequena inclinação



Cierre para candado  
Closing for padlock  
Fermeture pour cadenas  
Fechadura para cadeado

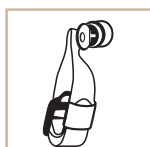

Pulsera de nylon  
Bracelet of nylon  
Bracelet en nylon  
Pulseira de náilon



Pulsera elástica  
Elastic Bracelet  
Bracelet élastique  
Pulseira elástica



SERIE FV

SERIE FT

SERIE FM

SERIE FC

SERIE FP

SERIE FB

SERIE FZ

SERIE FL

**COLORES STANDARD PUERTAS / STANDARD DOORS COLOURS / COULEURS PORTES STANDARD / CORES DE PORTAS STANDARD**



FBLANCO-1 FH-162 FV-097 FX-027 FK-096 FY-018 FY-571 FF-036 FF-087 FT-100 FV-021 FL-021 FF-623 FM-168 FM-100 FM-200 FF-405

OTROS COLORES CONSULTAR / OTHER COLOURS ON REQUEST / AUTRES COULEURS SUR DEMANDE / OUTRAS CORES PERGUNTAR









SERIE FV

**FV-30/1** COD. 53001    **FV-30/2** COD. 53101    **FV-30/3** COD. 53102    **FV-30/4** COD. 53103    **FV-40/1** COD. 53002    **FV-40/2** COD. 53112    **FV-40/3** COD. 53113

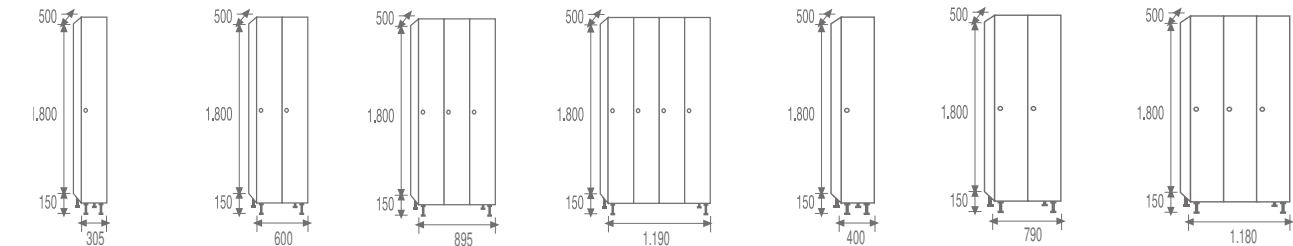

43,60Kg. • 0,27m<sup>3</sup>    74,05Kg. • 0,54m<sup>3</sup>    104,30Kg. • 0,81m<sup>3</sup>    134,85Kg. • 1,07m<sup>3</sup>    49Kg. • 0,36m<sup>3</sup>    84,85Kg. • 0,71m<sup>3</sup>    120,80Kg. • 1,06m<sup>3</sup>

SERIE FT

**FT-30/1** COD. 53011    **FT-30/2** COD. 53120    **FT-30/3** COD. 53121    **FT-30/4** COD. 53122    **FT-40/1** COD. 53012    **FT-40/2** COD. 53123    **FT-40/3** COD. 53124

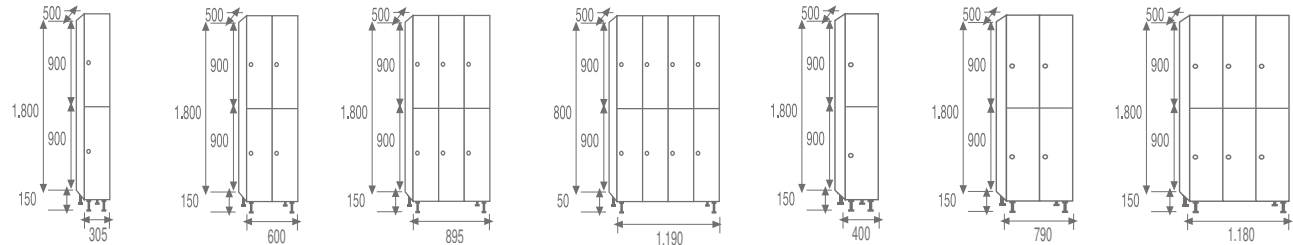

44,10Kg. • 0,27m<sup>3</sup>    75,05Kg. • 0,54m<sup>3</sup>    105,80Kg. • 0,81m<sup>3</sup>    136,85Kg. • 1,07m<sup>3</sup>    49,50Kg. • 0,36m<sup>3</sup>    85,85Kg. • 0,71m<sup>3</sup>    122,30Kg. • 1,06m<sup>3</sup>

SERIE FM

**FM-30/1** COD. 53031    **FM-30/2** COD. 53131    **FM-30/3** COD. 53132    **FM-30/4** COD. 53133    **FM-40/1** COD. 53032    **FM-40/2** COD. 53134    **FM-40/3** COD. 53135

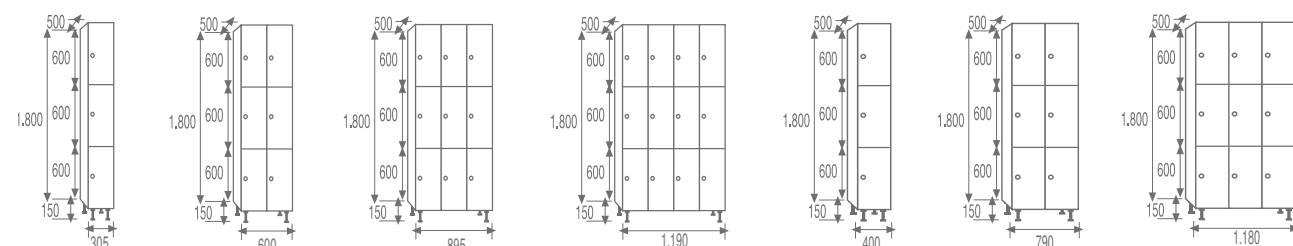

47Kg. • 0,27m<sup>3</sup>    80Kg. • 0,54m<sup>3</sup>    114Kg. • 0,81m<sup>3</sup>    148Kg. • 1,07m<sup>3</sup>    53Kg. • 0,36m<sup>3</sup>    93Kg. • 0,71m<sup>3</sup>    133Kg. • 1,06m<sup>3</sup>

SERIE FC

**FC-30/1** COD. 53021    **FC-30/2** COD. 53141    **FC-30/3** COD. 53142    **FC-30/4** COD. 53143    **FC-40/1** COD. 53022    **FC-40/2** COD. 53144    **FC-40/3** COD. 53145

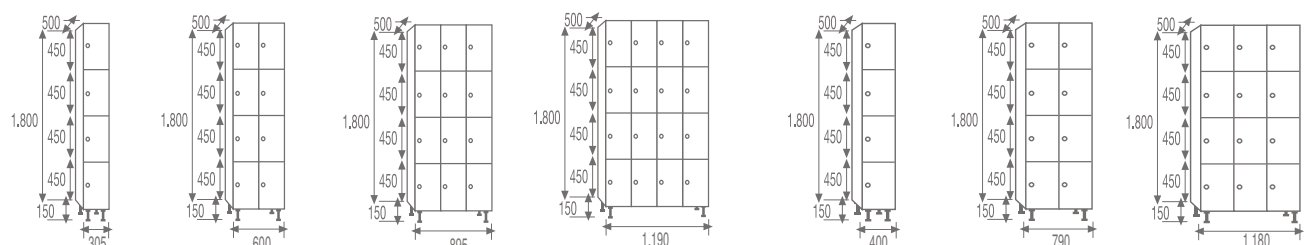

50Kg. • 0,27m<sup>3</sup>    86Kg. • 0,54m<sup>3</sup>    122Kg. • 0,81m<sup>3</sup>    158Kg. • 1,07m<sup>3</sup>    56Kg. • 0,36m<sup>3</sup>    99Kg. • 0,71m<sup>3</sup>    143Kg. • 1,06m<sup>3</sup>

SERIEFP

FP-30/1 COD. 53051	FP-30/2 COD. 53151	FP-30/3 COD. 53152	FP-30/4 COD. 53153	FP-40/1 COD. 53052	FP-40/2 COD. 53154	FP-40/3 COD. 53155
52Kg. • 0,27m <sup>3</sup>	91Kg. • 0,54m <sup>3</sup>	130Kg. • 0,81m <sup>3</sup>	169Kg. • 1,07m <sup>3</sup>	60Kg. • 0,36m <sup>3</sup>	106Kg. • 0,71m <sup>3</sup>	153Kg. • 1,06m <sup>3</sup>

SERIEFB

FB-30/1 COD. 53061	FB-30/2 COD. 53161	FB-30/3 COD. 53162	FB-30/4 COD. 53163	FB-40/1 COD. 53062	FB-40/2 COD. 53164	FB-40/3 COD. 53165
55Kg. • 0,27m <sup>3</sup>	96Kg. • 0,54m <sup>3</sup>	138Kg. • 0,81m <sup>3</sup>	180Kg. • 1,07m <sup>3</sup>	63Kg. • 0,36m <sup>3</sup>	113Kg. • 0,71m <sup>3</sup>	164Kg. • 1,06m <sup>3</sup>

SERIEFZ

FZ-30/1 COD. 53081	FZ-30/2 COD. 53171	FZ-30/3 COD. 53172	FZ-30/4 COD. 53173	FZ-40/1 COD. 53082	FZ-40/2 COD. 53174	FZ-40/3 COD. 53175
60Kg. • 0,27m <sup>3</sup>	107Kg. • 0,54m <sup>3</sup>	154Kg. • 0,81m <sup>3</sup>	201Kg. • 1,07m <sup>3</sup>	70Kg. • 0,36m <sup>3</sup>	127Kg. • 0,71m <sup>3</sup>	184Kg. • 1,06m <sup>3</sup>

SERIEFL

FL-30/1 COD. 53041	FL-30/2 COD. 53181	FL-30/3 COD. 53182	FL-30/4 COD. 53183	FL-40/1 COD. 53042	FL-40/2 COD. 53184	FL-40/3 COD. 53185
51Kg. • 0,27m <sup>3</sup>	92Kg. • 0,54m <sup>3</sup>	134Kg. • 0,81m <sup>3</sup>	175Kg. • 1,07m <sup>3</sup>	56Kg. • 0,36m <sup>3</sup>	103Kg. • 0,71m <sup>3</sup>	150Kg. • 1,06m <sup>3</sup>

CARACTERÍSTICAS / CHARACTERISTICS / CARACTERISTIQUES / CARACTERISTICAS



Espesores.  
Thicknesses.  
Épaisseurs.  
Espessura.



Tornillería y bisagras en acero inoxidable.  
Screws and hinges in stainless steel.  
Vis et charnières en acier inoxydable.  
Parafusos e dobradiças em aço inox.



Cuerpo.  
Body.  
Corps.  
Corpo.



Material de gran resistencia, hidrófugo, ignífugo y antibacteriano.  
Material of great resistance, hydrophobic, fire resistant and antibacterial.  
Matériel très résistant, hydrofuge, ignifuge et antibactérien.  
Material muito resistente, hidrófugo, ignífugo e antibacteriano.



Taquillas fabricadas en tablero compacto de resinas fenólicas.  
Lockers manufactured with compact panels made of phenolic resins.  
Vestiaires fabriqués en stratifié compact.  
Cacifos construídos em resinas fenólicas.



Recomendado para ambientes húmedos. Resistente al agua. Waterproof.  
Recommended for wet areas. Waterproof.  
Récommandé pour les environnements humides.  
Recomendado para lugares com humidade. Resistente a água.



Pata regulable en altura.  
Legs adjustable in height.  
Pieds réglables en hauteur.  
Pés reguláveis em altura.



Cantos redondeados.  
Rounded edges.  
Sans arête vive.  
Cantos redondeados.



Fácil limpieza.  
Easy cleaning.  
Nettoyage facile.  
Fácil limpeza.



OPCIÓN INOX / OPTION INOX / OPTION INOX / OPÇÃO INOX



# CABINAS FENÓLICAS

PHENOLIC CABINS  
CABINES PHÉNOLIQUES  
CABINES FENÓLICAS







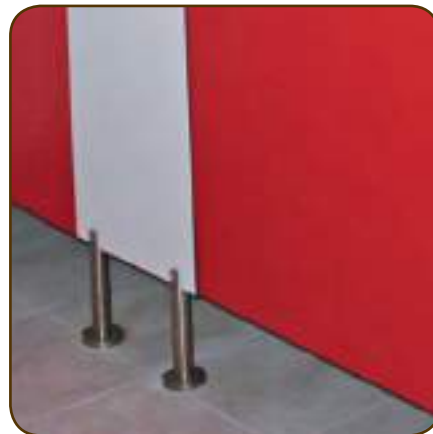





BANCOS DE VESTUARIO

BENCH SEATS

BANCS POUR VESTIAIRES

BANCOS DE VESTIÁRIO



CARACTERÍSTICAS / CHARACTERISTICS / CARACTERISTIQUES / CARACTERISTICAS



Fácil montaje.  
Easy assembly.  
Montage facile.  
Facil montagem.



Gran resistencia.  
Great resistance.  
Très résistant.  
Muito resistente.



Recomendado para ambientes húmedos.  
Recommended for wet areas. Waterproof.  
Recommandé pour les environnements humides.  
Recomendado para lugares com humidade.



No es recomendable para espacios húmedos.  
Not recommended for wet spaces.  
Pas recommandé pour les environnements humides.  
Nao é recomendável para lugares com humidade.



Estructura soldada.  
Welded structure.  
Structure soudée.  
Estrutura soldada.



Fabricado en PVC.  
Manufactured in PVC.  
Fabriqué en pvc.  
Fabricação em pvc.



Fabricado en tubo de acero.  
Manufactured in steel tube.  
Fabriqué en tube d'acier.  
Construção em tubo de aço.



Chasis de tubo de acero.  
Steel tube chassis.  
Structure en tube d'acier soudé.  
Estrutura em tubo de aço soldado.



Se sirve desmontado.  
Delivered disassembled.  
Fourni démonté.  
Fornecemos tudo desmontado.

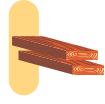

Listones de pino barnizado.  
Varnished pine wood slats.  
Lames de pin verni.  
Assento de pinheiro envernizado.



Microtexturado.  
Microtextured.  
Microtexturé.  
Microtexturado.



Sin montaje.  
Without assembly.  
Pas de montage.  
Sem montagem.



Pintado en Epoxi.  
Painted in Epoxy.  
Peinture en epoxi.  
Pintura em epoxi.



Color standard: Gris RAL 7035.  
Standard colour: Grey RAL 7035.  
Couleur standard: gris ral 7035.  
Cor standard: cinza ral 7035.



Pata regulable en altura.  
Legs adjustable in height.  
Pieds réglables en hauteur.  
Pés reguláveis em altura.



Perchas de zamak de triple gancho.  
Triple zamak hooks.  
Crochets en zamak.  
Ganchos triplos de zamak.



Espesores.  
Thicknesses.  
Épaisseurs.  
Espessura.



Bancos fabricados en tablero compacto de resinas fenólicas.  
Bench seats manufactured with HPL.  
Bancs pour vestiaires fabriqués en stratifié compact.  
Bancos de vestário comstruidos em resinas fenólicas.



Material de gran resistencia, hidrófugo, ignífugo y antibacteriano.  
Material of great resistance, hydrophobic, fire resistant and antibacterial.  
Matériel très résistant, hydrofuge, ignifuge et antibactérien.  
Material muito resistente, hidrófugo, ignífugo e antibacteriano.



Cantos redondeados.  
Rounded edges.  
Sans arête vive.  
Cantos redondeados.



Estructura en acero inoxidable AISI 304.  
Structure made of stainless steel AISI 304.  
Structure en acier inoxydable aisi 304.  
Estrutura em aço inox aisi 304.



Tablero de resina de polipropileno.  
Panel made of polypropylene resin.  
Panneau en résine de polypropilène.  
Painel de resina de polipropolene.



Plegable.  
Foldable.  
Pliant.  
Plegavel.



Canteado PVC.  
PVC-Edged.  
Finitions en PVC.  
Finição em PVC.



Fácil limpieza.  
Easy cleaning.  
Nettoyage facile.  
Fácil limpeza.



Inox.  
Stainless steel.  
Inox.  
Inox.



Asiento con lamas de tablero fenólico de 10 mm de espesor y repisa zapatero.  
Seat made of phenolic slats of 10 mm thickness and shoe rack.  
Assise avec lames en stratifié compact épaisseur 10 mm et étagère pour chaussures.  
Assento em fenólico de 10 mm de espessura e opção sapateiro.



Asiento de melamina y repisa de acero.  
Seat in melamine and steel shoe rack.  
Assise en mélamine et étagère pour chaussures en acier.  
Assento de madeira de tola e repisa para os sapatos em aço.



Asiento y repisa de melamina de 16 mm.  
Seat and shoe rack in melamine of 16 mm thickness.  
Assise et étagère pour chaussures en mélamine de 16 mm.  
Assento e opção para por os sapatos de madeira de tola de 16 mm.



Patas de acero.  
Steel legs.  
Pieds en acier.  
Pés em aço.



Tornillería en acero inoxidable.  
Screws in stainless steel.  
Vis en acier inoxydable.  
Parafusos em aço inox.





**MOD. BANC-2-1500**  
COD. 79013



**MOD. BANC-3-1500-FEN DC**  
COD. 79558

BANCOS DE VESTUARIO  
BENCH SEATS  
BANCS POUR VESTIAIRES  
BANCOS DE VESTIÁRIO



**MOD. REP-FEN-1500**  
COD. 79941



**MOD. COLG-3-2000**  
COD. 79920



**MOD. BANC-H-1500**  
COD. 79150



**MOD. BANC-1-PVC-1000**  
COD. 79101



**MOD. BANC-ME-1500**  
COD. 79009

## BANCOS EN ACERO

STEEL BENCH SEATS  
BANCS EN ACIER  
BANCOS EM AÇO



**MOD. BANC-H-1500**  
COD. 79150



**Opción: Contera regulable en altura**  
Option: Legs adjustable  
Option: Pieds réglables  
Opção: pés reguláveis



**Opción: Fijación a suelo**  
Option: Floor fixing  
Option: fixation au sol  
Opção: fixação Piso

COD.	MOD.	↑↓	↔	↗	kg	M <sup>3</sup>
79100	BANC-H-1000	530	1000	350	12,0	0,19
79150	BANC-H-1500	530	1500	350	18,0	0,28
79200	BANC-H-2000	530	2000	350	24,0	0,37

### CARACTERÍSTICAS / CHARACTERISTICS / CARACTERISTIQUES / CARACTERISTICAS



## COLGADORES

WALL COAT HOOK  
PATERES  
CABIDES



**MOD. COLG-6-900**  
COD. 79960



**MOD. COLG-5-600**  
COD. 79955



**MOD. COLG-4-400**  
COD. 79950



**MOD. COLG-3-2000**  
COD. 79920



**MOD. COLG-2-1500**  
COD. 79915



**MOD. COLG-1-1000**  
COD. 79910

## BANCOS EN MADERA Y ACERO

WOODEN AND STEEL BENCH SEATS  
BANCS EN BOIS ET DE L'ACIER  
BANCOS EM MADEIRA E AÇO



MOD. BANC-1-1500  
COD. 79001



**Opción repisa zapatero**  
Shoe rack option  
Option étagère pour  
chaussures  
Opção sapateiro



**Opción: Fijación a suelo**  
Option: Floor fixing  
Option: fixation au sol  
Opção: fixação Piso



**Opción: Contera regulable en altura**  
Option: Legs adjustable  
Option: Pieds réglables  
Opção: pés reguláveis



### CARACTERÍSTICAS / CHARACTERISTICS / CARACTERISTIQUES / CARACTERISTICAS



COD.	MOD.	↑↓	↔	↗↘	kg	M <sup>3</sup>
79004	BANC-mini	480	700	340	8,0	0,11
79010	BANC-1-1000	480	1000	340	9,5	0,16
79001	BANC-1-1500	480	1500	340	14,0	0,23
79020	BANC-1-2000	480	2000	340	18,0	0,31

## BANCOS EN MADERA Y ACERO

WOODEN AND STEEL BENCHES SEATS

BANCS EN BOIS ET DE L'ACIER

BANCOS EM MADEIRA E AÇO



**Opción repisa zapatero**  
Shoe rack option  
Option étagère pour chaussures  
Opção sapateiro



**Opción: Fijación a suelo**  
Option: Floor fixing  
Option: fixation au sol  
Opção: fixação Piso



**Opción: Contera regulable en altura**  
Option: Legs adjustable  
Option: Pieds réglables  
Opção: pés reguláveis



**MOD. BANC-2-1500**  
COD. 79013



**MOD. BANC-2-1500 DC**  
COD. 79213

### CARACTERÍSTICAS / CHARACTERISTICS / CARACTERISTIQUES / CARACTERISTICAS

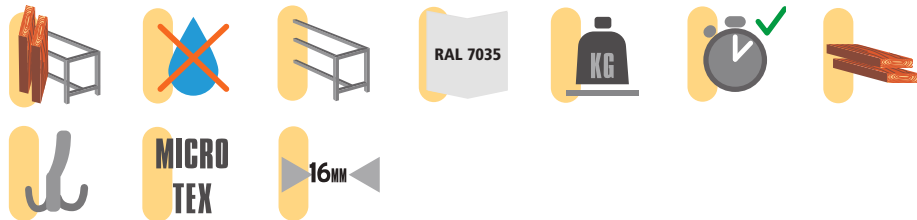

COD.	MOD.	↑↓	↔	↗↘	⌋	kg	M <sup>3</sup>
79012	BANC-2-1000	1745	1000	355	4	16,0	0,23
79013	BANC-2-1500	1745	1500	355	7	24,0	0,30
79014	BANC-2-2000	1745	2000	355	9	29,0	0,31
79212	BANC-2-1000 DC	1745	1000	685	8	28,0	0,46
79213	BANC-2-1500 DC	1745	1500	685	12	42,0	0,60
79214	BANC-2-2000 DC	1745	2000	685	16	52,0	0,62

## BANCOS EN MADERA Y ACERO

WOODEN AND STEEL BENCHES SEATS

BANCS EN BOIS ET DE L'ACIER

BANCOS EM MADEIRA E AÇO



**Opción repisa zapatero**  
Shoe rack option  
Option étagère pour chaussures  
Opção sapateiro



**Opción: Fijación a suelo**  
Option: Floor fixing  
Option: fixation au sol  
Opção: fixação Piso



**Opción: Contera regulable en altura**  
Option: Legs adjustable  
Option: Pieds réglables  
Opção: pés reguláveis



**MOD. BANC-3-1500**  
COD. 79023



**MOD. BANC-3-1500 DC**  
COD. 79223

### CARACTERÍSTICAS / CHARACTERISTICS / CARACTERISTIQUES / CARACTERISTICAS

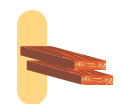
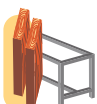

COD.	MOD.	↑↓	↔	↗↘	⌋	kg	M <sup>3</sup>
79022	BANC-3-1000	1800	1000	355	4	21,5	0,28
79023	BANC-3-1500	1800	1500	355	7	28,5	0,36
79024	BANC-3-2000	1800	2000	355	9	33,5	0,45
79222	BANC-3-1000 DC	1800	1000	685	8	37,0	0,48
79223	BANC-3-1500 DC	1800	1500	685	12	51,0	0,62
79224	BANC-3-2000 DC	1800	2000	685	16	61,0	0,64



## BANCOS EN MADERA Y ACERO

WOODEN AND STEEL BENCH SEATS  
BANCS EN BOIS ET DE L'ACIER  
BANCOS EM MADEIRA E AÇO



Opción repisa zapatero  
Shoe rack option  
Option étagère pour  
chaussures  
Opção sapateiro

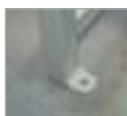

Opción: Fijación a suelo  
Option: Floor fixing  
Option: fixation au sol  
Opção: fixação Piso



Opción: Contera  
regulable en altura  
Option: Legs adjustable  
Option: Pieds réglables  
Opção: pés reguláveis

COD.	MOD.	↑↓	↔	↗↘	kg	M <sup>3</sup>
79300	BANC-4-1000	810	1000	420	11,5	0,34
79325	BANC-4-1500	810	1500	420	16,5	0,51
79350	BANC-4-2000	810	2000	420	20,5	0,68

### CARACTERÍSTICAS / CHARACTERISTICS / CARACTERISTIQUES / CARACTERISTICAS



## REPISAS

WOODEN AND STEEL BENCH SEATS  
BANCS EN BOIS ET DE L'ACIER  
BANCOS EM MADEIRA E AÇO



MOD. REP-MAD-1500  
COD. 79916

COD.	MOD.	↑↓	↔	↗↘	hook	kg	M <sup>3</sup>
79911	REP-MAD-1000	270	1.000	355	4	7,0	0,11
79916	REP-MAD-1500	270	1.500	355	7	10,0	0,16
79921	REP-MAD-2000	270	2.000	355	9	13,0	0,22

### CARACTERÍSTICAS / CHARACTERISTICS / CARACTERISTIQUES / CARACTERISTICAS

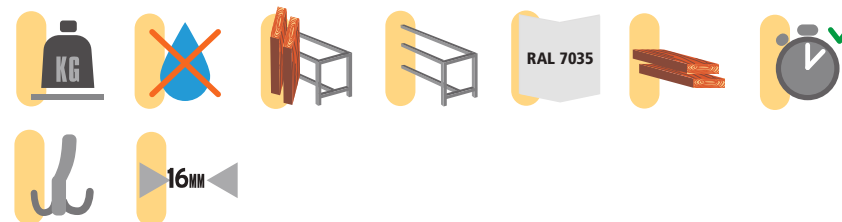

## BANCOS EN MADERA

WOODEN BENCH SEATS  
BANCS EN BOIS  
BANCOS EM MADEIRA



MOD. BANC-1-1500-MA  
COD. 79425

COD.	MOD.	↑	↔	↗	kg	M <sup>3</sup>
79400	BANC-1-1000-MA	480	1000	330	8,0	0,16
79425	BANC-1-1500-MA	480	1500	330	12,0	0,24
79450	BANC-1-2000-MA	480	2000	330	16,0	0,32

## BANCOS EN MADERA

WOODEN BENCH SEATS  
BANCS EN BOIS  
BANCOS EM MADEIRA

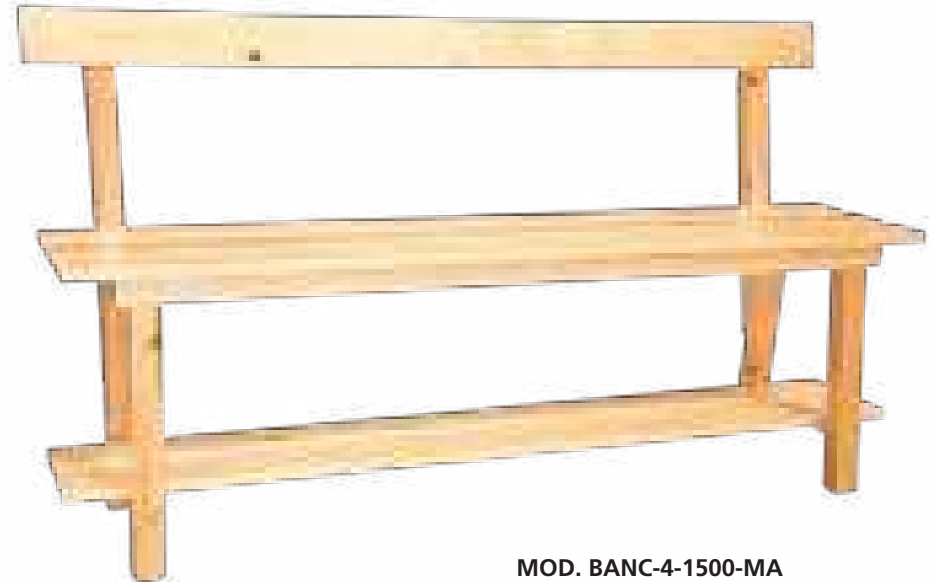

MOD. BANC-4-1500-MA  
COD. 79435

COD.	MOD.	↑	↔	↗	kg	M <sup>3</sup>
79410	BANC-4-1000-MA	830	1000	390	12	0,33
79435	BANC-4-1500-MA	830	1500	390	17	0,49
79460	BANC-4-2000-MA	830	2000	390	21	0,65

### CARACTERÍSTICAS / CHARACTERISTICS / CARACTERISTIQUES / CARACTERISTICAS



### CARACTERÍSTICAS / CHARACTERISTICS / CARACTERISTIQUES / CARACTERISTICAS



## BANCOS EN PVC

PVC BENCH SEATS  
BANCS EN PVC  
BANCOS EM PVC



MOD. BANC-1-PVC-1500  
COD. 79102

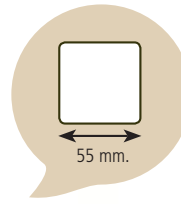

MOD. BANC-1-PVC-2000-DC  
COD. 79113



MOD. BANC-PARED-1500-PVC  
COD. 79115

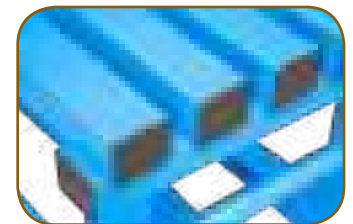

### TUBO / TUBE / TUBE / TUBO

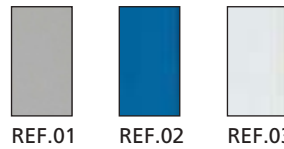

### TAPONES / CAPS / BOUCHONS / TAMPA



### CARACTERÍSTICAS / CHARACTERISTICS / CARACTERISTIQUES / CARACTERISTICAS



COD.	MOD.	↑	↔	↗	kg	M <sup>3</sup>
79101	BANC-1-PVC-1000	490	1.000	420	8	0,20
79102	BANC-1-PVC-1500	490	1.500	420	10	0,30
79103	BANC-1-PVC-2000	490	2.000	420	13	0,41
79111	BANC-1-PVC-1000-DC	490	1.000	750	15	0,37
79112	BANC-1-PVC-1500-DC	490	1.500	750	18	0,55
79113	BANC-1-PVC-2000-DC	490	2.000	750	24	0,73
79114	BANC-PARED-PVC-1000	370	1.000	325	10	0,12
79115	BANC-PARED-PVC-1500	370	1.500	325	12	0,18
79116	BANC-PARED-PVC-2000	370	2.000	325	15	0,24

## BANCOS EN PVC

PVC BENCH SEATS

BANCS EN PVC

BANCOS EM PVC



MOD. BANC-3-PVC-1500  
COD. 79132



MOD. BANC-3-PVC-1500 DC  
COD. 79164

TUBO / TUBE / TUBE / TUBO



TAPONES / CAPS /  
BOUCHONS / TAMPA



CARACTERÍSTICAS / CHARACTERISTICS /  
CARACTERISTIQUES / CARACTERISTICAS



COD.	MOD.	↑	↔	↗	⌋	kg	M <sup>3</sup>
79131	BANC-3-PVC-1000	1950	1.000	500	4	17	0,30
79132	BANC-3-PVC-1500	1950	1.500	500	6	22	0,45
79133	BANC-3-PVC-2000	1950	2.000	500	8	28	0,61
79162	BANC-3-PVC-1000-DC	1950	1.000	750	8	32	0,50
79164	BANC-3-PVC-1500-DC	1950	1.500	750	12	39	0,75
79166	BANC-3-PVC-2000-DC	1950	2.000	750	16	52	1,02



## ESTANTERÍAS EN PVC

PVC RACKS

RAYONNAGES EN PVC

ESTANTES EM PVC





# ESTANTERÍAS EN PVC

PVC RACKS  
RAYONNAGES EN PVC  
ESTANTES EM PVC

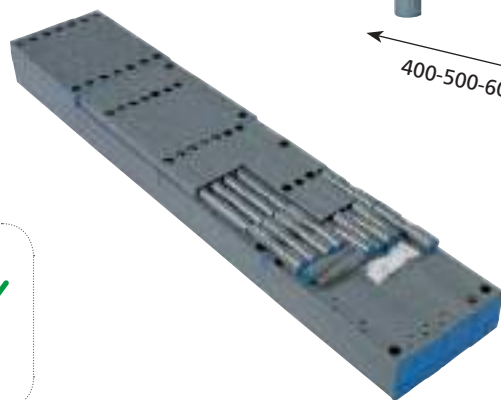

**CARACTERÍSTICAS / CHARACTERISTICS /**  
CARACTERISTIQUES / CARACTERISTICAS



**TUBO / TUBE / TUBE / TUBO**

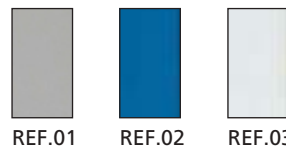

**TAPONES / CAPS /**  
BOUCHONS / TAMPA





MOD. BANC-FI-1500  
COD.79006

COD.	MOD.	↕	↔	↗	kg	M <sup>3</sup>
79005	BANC-FI-1000	460	1000	325	11,7	0,15
79006	BANC-FI-1500	460	1500	325	17,5	0,22
79007	BANC-FI-2000	460	2000	325	20,5	0,30

CARACTERÍSTICAS / CHARACTERISTICS / CARACTERISTIQUES / CARACTERISTICAS

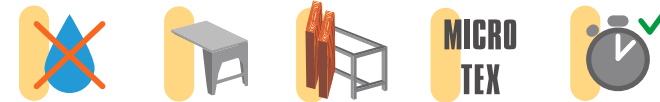

MOD. BANC-ME-1500  
COD.79009

COD.	MOD.	↕	↔	↗	kg	M <sup>3</sup>
79008	BANC-ME-1000	480	1000	325	12,0	0,19
79009	BANC-ME-1500	480	1500	325	16,5	0,29
79011	BANC-ME-2000	480	2000	325	20,5	0,38

CARACTERÍSTICAS / CHARACTERISTICS / CARACTERISTIQUES / CARACTERISTICAS



MOD. BANC-MHD-1500  
COD.79016

COD.	MOD.	↕	↔	↗	kg	M <sup>3</sup>
79015	BANC-MHD-1000	460	1000	325	12,0	0,15
79016	BANC-MHD-1500	460	1500	325	16,5	0,22
79017	BANC-MHD-2000	460	2000	325	20,5	0,30

CARACTERÍSTICAS / CHARACTERISTICS / CARACTERISTIQUES / CARACTERISTICAS



## BANCOS EN FENÓLICO

PHENOLIC BENCH SEATS  
BANCS EN STRATIPIÉ MASSIF  
BANCOS EM FÓRMICA

Opción repisa zapatero  
Shoe rack option  
Option étagère pour chaussures  
Opção: sapateiro

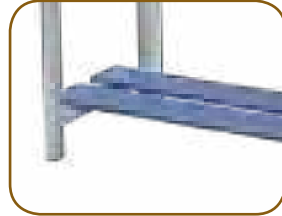

MOD. BANC-1-1500-FEN  
COD. 79502



MOD. BANC-PARED 1500-FEN  
COD. 79511

Opción: Fijación a suelo  
Option: Floor fixing  
Option: fixation au sol  
Opção: fixação Piso



COD.	MOD.	↑↓	↔	↗↘	kg	M <sup>3</sup>
79501	BANC-1-1000-FEN	480	1000	340	12,0	0,16
79502	BANC-1-1500-FEN	480	1500	340	18,0	0,24
79503	BANC-1-2000-FEN	480	2000	340	24,0	0,33
79510	BANC-PARED 1000-FEN	330	1000	400	9,0	0,13
79511	BANC-PARED 1500-FEN	330	1500	400	15,0	0,20
79512	BANC-PARED 2000-FEN	330	2000	400	21,0	0,26

### CARACTERÍSTICAS / CHARACTERISTICS / CARACTERISTIQUES / CARACTERISTICAS

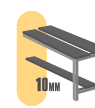

Opción/Option  
Option/Opção



### COLORES STANDARD / STANDARD COLOURS / COULEURS STANDARD / CORES STANDARD

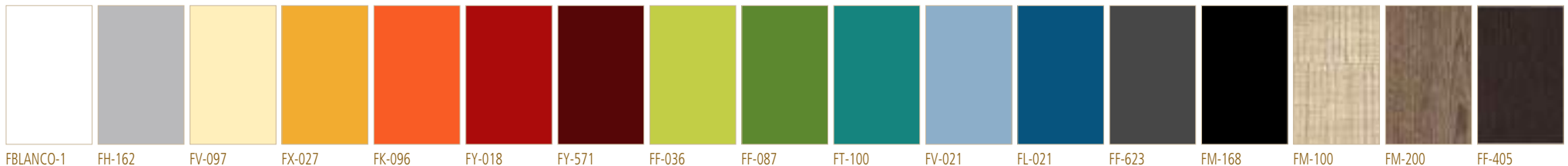

FBLANCO-1

FH-162

FV-097

FX-027

FK-096

FY-018

FY-571

FF-036

FF-087

FT-100

FV-021

FL-021

FF-623

FM-168

FM-100

FM-200

FF-405

OTROS COLORES CONSULTAR / OTHER COLOURS ON REQUEST / AUTRES COULEURS SUR DEMANDE / OUTRAS CORES PERGUNTAR

## BANCOS EN FENÓLICO

PHENOLIC BENCH SEATS  
BANCS EN STRATIÉE MASSIF  
BANCOS EM FÓRMICA



**MOD. BANC-2-1500-FEN**  
COD. 79505



**MOD. BANC-3-1500-FEN**  
COD. 79508



**Contera regulable en altura**  
Legs adjustable  
Pieds réglables  
Pés reguláveis

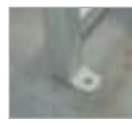

**Opción: Fijación a suelo**  
Option: Floor fixing  
Option: fixation au sol  
Opção: fixação Piso

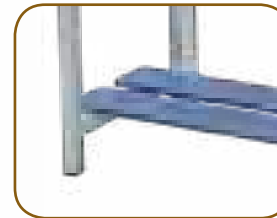

**Opción repisa zapatero**  
Shoe rack option  
Option étagère pour chaussures  
Opção: sapateiro

### CARACTERÍSTICAS / CHARACTERISTICS / CARACTERISTIQUES / CARACTERISTICAS

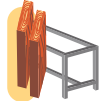

COD.	MOD.	↑↓	↔	↗↘	⌋	kg	M <sup>3</sup>
79504	BANC-2-1000-FEN	1745	1000	355	5	24,0	0,23
79505	BANC-2-1500-FEN	1745	1500	355	8	32,0	0,30
79506	BANC-2-2000-FEN	1745	2000	355	10	37,0	0,31
79507	BANC-3-1000-FEN	1800	1000	355	5	31,5	0,23
79508	BANC-3-1500-FEN	1800	1500	355	8	38,5	0,30
79509	BANC-3-2000-FEN	1800	2000	355	10	43,5	0,31



## BANCOS EN FENÓLICO DOBLE CARA

PHENOLIC BENCH SEATS  
BANCS EN STRATIPIÈ MASSIF  
BANCOS EM FÓRMICA



Opción repisa zapatero  
Shoe rack option  
Option étagère pour chaussures  
Opção: sapateiro

MOD. BANC-2-1000-FEN DC  
COD. 79554

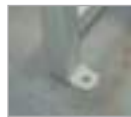

Opción: Fijación a suelo  
Option: Floor fixing  
Option: fixation au sol  
Opção: fixação Piso



Contera regulable en altura  
Legs adjustable  
Pieds réglables  
Pés reguláveis

### CARACTERÍSTICAS / CHARACTERISTICS / CARACTERISTIQUES / CARACTERISTICAS

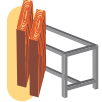

MOD. BANC-3-1500-FEN DC  
COD. 79558

COD.	MOD.	↑↓	↔	↗↘	⌋	⚖	M <sup>3</sup>
79557	BANC-3-1000-FEN DC	1800	1000	685	10	63	0,46
79558	BANC-3-1500-FEN DC	1800	1500	685	16	77	0,60
79559	BANC-3-2000-FEN DC	1800	2000	685	20	87	0,62
79554	BANC-2-1000-FEN DC	1745	1000	685	10	48	0,46
79555	BANC-2-1500-FEN DC	1745	1500	685	16	64	0,60
79556	BANC-2-2000-FEN DC	1745	2000	685	20	74	0,62



## COLGADORES

WALL COAT HOOK  
PATERES  
CABIDES



MOD. PER-FEN-1000  
COD. 79930

COD.	MOD.	↑↓	↔	↗↘	⬇	kg	M³
79930	PER-FEN-1000	110	1000		5	3,0	0,009
79931	PER-FEN-1500	110	1500		8	5,0	0,013
79932	PER-FEN-2000	110	2000		10	8,0	0,018

## REPISAS

WOODEN AND STEEL BENCH SEATS  
BANCS EN BOIS ET DE L'ACIER  
BANCOS EM MADEIRA E AÇO



MOD. REP-FEN-1500  
COD. 79941

COD.	MOD.	↑↓	↔	↗↘	⬇	kg	M³
79940	REP-FEN-1000	270	1000	400	5	8,0	0,11
79941	REP-FEN-1500	270	1500	400	8	11,0	0,16
79942	REP-FEN-2000	270	2000	400	10	14,0	0,22



## BANCOS EN FENÓLICO DISEÑO

PHENOLIC BENCH SEATS DESIGN

BANCS EN STRATIÉE MASSIF CONCEPTION

BANCOS EM FÓRMICA PROJETO



MOD.BANC-1-1500-DIS  
COD. 79625



**CARACTERÍSTICAS / CHARACTERISTICS /**  
CARACTERISTIQUES / CARACTERISTICAS



COD.	MOD.	↑↓	↔	↗	kg	M <sup>3</sup>
79600	BANC-1-1000-DIS	490	1000	350	20,0	0,17
79625	BANC-1-1500-DIS	490	1500	350	26,0	0,26
79650	BANC-1-2000-DIS	490	2000	350	32,0	0,34

**COLORES STANDARD / STANDARD COLOURS / COULEURS STANDARD / CORES STANDARD**

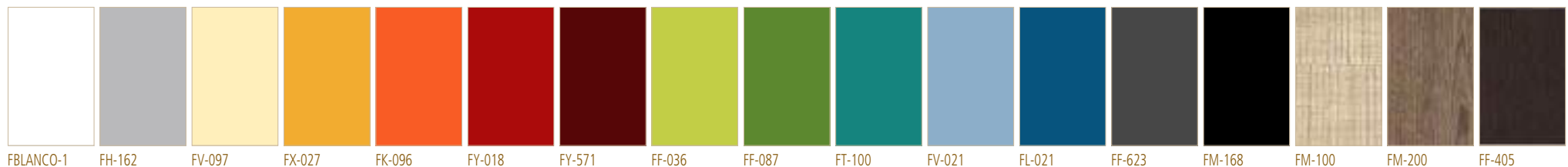

FBLANCO-1 FH-162 FV-097 FX-027 FK-096 FY-018 FY-571 FF-036 FF-087 FT-100 FV-021 FL-021 FF-623 FM-168 FM-100 FM-200 FF-405

OTROS COLORES CONSULTAR / OTHER COLOURS ON REQUEST / AUTRES COULEURS SUR DEMANDE / OUTRAS CORES PERGUNTAR

## BANCOS EN FENÓLICO MOD. ISLA

PHENOLIC BENCH SEATS  
BANCS EN STRATIPIÉ MASSIF  
BANCOS EM FÓRMICA



MOD: BANC-1-1500-ISL  
COD. 79702



MOD: BANC-2-1500-ISL  
COD. 79705



MOD: BANC-3-1500-ISL  
COD. 79708

### CARACTERÍSTICAS / CHARACTERISTICS / CARACTERISTIQUES / CARACTERISTICAS



COD.	MOD.	↑	↔	↗	↓	kg	M <sup>3</sup>
79701	BANC-1-1000-ISL	480	1000	340	-	14,0	0,16
79702	BANC-1-1500-ISL	480	1500	340	-	20,0	0,24
79703	BANC-1-2000-ISL	480	2000	340	-	26,0	0,33
79704	BANC-2-1000-ISL	1745	1000	370	5	26,0	0,23
79705	BANC-2-1500-ISL	1745	1500	370	8	34,0	0,30
79706	BANC-2-2000-ISL	1745	2000	370	10	39,0	0,31
79707	BANC-3-1000-ISL	1800	1000	370	5	33,5	0,23
79708	BANC-3-1500-ISL	1800	1500	370	8	40,5	0,30
79709	BANC-3-2000-ISL	1800	2000	370	10	45,5	0,31



MOD: BANC-1-1500-ISL-DC  
COD. 79752



MOD. BANC-2-1500-ISL-DC  
COD. 79755



MOD. BANC-3-1500-ISL-DC  
COD. 79758

COD.	MOD.	↑↓	↔	↗↘	↓	kg	M <sup>3</sup>
79751	BANC-1-1000-ISL-DC	480	1000	710	-	26,0	0,34
79752	BANC-1-1500-ISL-DC	480	1500	710	-	38,0	0,51
79753	BANC-1-2000-ISL-DC	480	2000	710	-	50,0	0,68
79754	BANC-2-1000-ISL-DC	1745	1000	710	10	50,0	0,46
79755	BANC-2-1500-ISL-DC	1745	1500	710	16	66,0	0,60
79756	BANC-2-2000-ISL-DC	1745	2000	710	20	76,0	0,62
79757	BANC-3-1000-ISL-DC	1800	1000	710	10	65,0	0,46
79758	BANC-3-1500-ISL-DC	1800	1500	710	16	79,0	0,60
79759	BANC-3-2000-ISL-DC	1800	2000	710	20	89,0	0,62



## BANCOS ECO EN MADERA Y ACERO

WOODEN AND STEEL ECO BENCHES  
BANCS ECO EN BOIS ET DE L'ACIER  
BANCOS ECO EM MADEIRA E AÇO



**MOD. BANC-ECO-1-1500**  
COD. 97001



**MOD. BANC-ECO-3-1500**  
COD. 97023



**MOD. BANC-ECO-3-1500-DC**  
COD. 97223



**Opción repisa zapatero**  
Shoe rack option  
Option étagère pour  
chaussures  
Opção sapateiro



**Opción: Fijación a suelo**  
Option: Floor fixing  
Option: fixation au sol  
Opção: fixação Piso



**Opción: Contera regulable en altura**  
Option: Legs adjustable  
Option: Pieds réglables  
Opção: pés reguláveis

### CARACTERÍSTICAS / CHARACTERISTICS / CARACTERISTIQUES / CARACTERISTICAS



**MICRO  
TEX**

**RAL 7035**

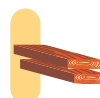

COD.	MOD.	↑↓	↔	↗↘	kg	M <sup>3</sup>
97010	BANC-ECO-1-1000	480	1000	325	9,5	0,16
97001	BANC-ECO-1-1500	480	1500	325	12	0,23
97020	BANC-ECO-1-2000	480	2000	325	16	0,31

COD.	MOD.	↑↓	↔	↗↘	⌋	kg	M <sup>3</sup>
97022	BANC-ECO-3-1000	1800	1000	355	4	21,5	0,28
97023	BANC-ECO-3-1500	1800	1500	355	7	24,5	0,36
97024	BANC-ECO-3-2000	1800	2000	355	9	29,5	0,45
97222	BANC-ECO-3-1000 DC	1800	1000	700	8	37,0	0,44
97223	BANC-ECO-3-1500 DC	1800	1500	700	12	44,0	0,61
97224	BANC-ECO-3-2000 DC	1800	2000	700	16	54,0	0,78



## BANCOS ECO EN MADERA Y ACERO

WOODEN AND STEEL ECO BENCHES

BANCS ECO EN BOIS ET DE L'ACIER

BANCOS ECO EM MADERA E AÇO



MOD. BANC-ECO-2-1500-DC  
COD. 97213



MOD. BANC-ECO-2-1500  
COD. 97013

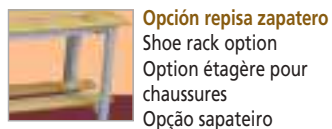

Opción repisa zapatero  
Shoe rack option  
Option étagère pour  
chaussures  
Opção sapateiro

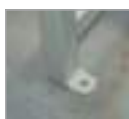

Opción: Fijación a suelo  
Option: Floor fixing  
Option: fixation au sol  
Opção: fixação Piso



Opción: Contera  
regulable en altura  
Option: Legs adjustable  
Option: Pieds réglables  
Opção: pés reguláveis

### CARACTERÍSTICAS / CHARACTERISTICS / CARACTERISTIQUES / CARACTERISTICAS



COD.	MOD.	↑	↔	↗	⌋	kg	M <sup>3</sup>
97012	BANC-ECO-2-1000	1745	1000	355	4	16,0	0,27
97013	BANC-ECO-2-1500	1745	1500	355	7	20,0	0,35
97014	BANC-ECO-2-2000	1745	2000	355	9	25,0	0,42
97212	BANC-ECO-2-1000 DC	1745	1000	700	8	28,0	0,42
97213	BANC-ECO-2-1500 DC	1745	1500	700	12	38,0	0,48
97214	BANC-ECO-2-2000 DC	1745	2000	700	16	48,0	0,73

## MESAS Y BANCOS PARA COMEDOR

TABLES AND BENCHES FOR DINING ROOMS  
DES TABLES ET DES BANCS POUR SALLE À MANGER  
MESAS E BANCOS PARA SALA

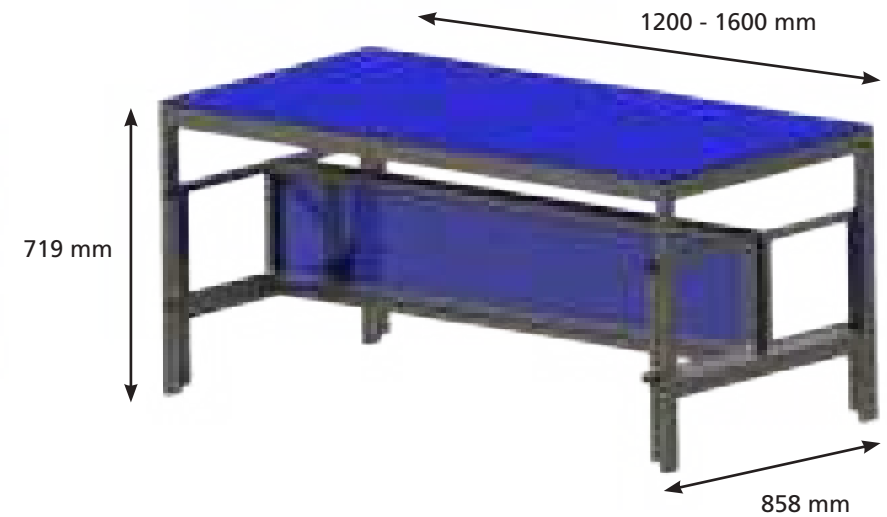
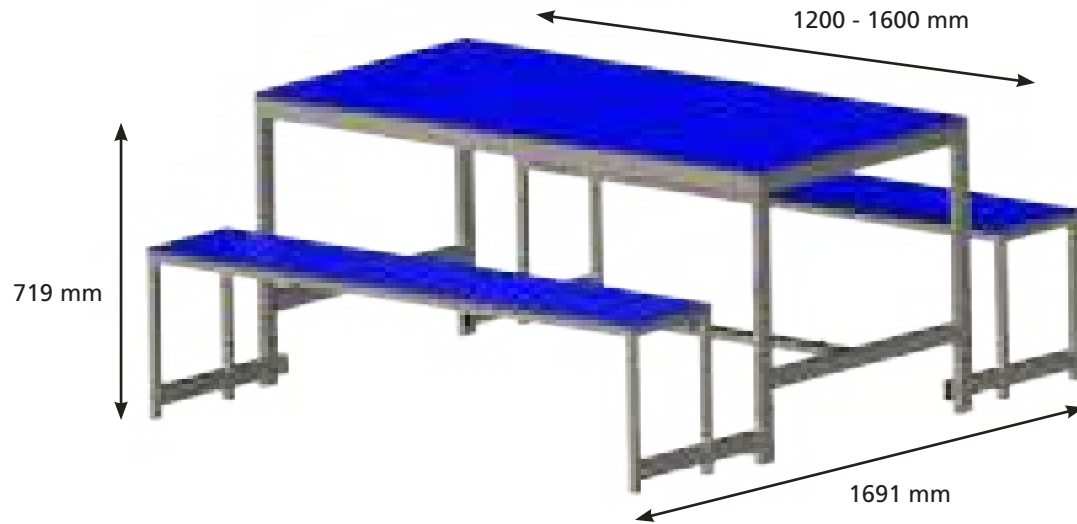

### CARACTERÍSTICAS / CHARACTERISTICS / CARACTERISTIQUES / CARACTERISTICAS



### COLORES STANDARD / STANDARD COLOURS / COULEURS STANDARD / CORES STANDARD



FBLANCO-1 FH-162 FV-097 FX-027 FK-096 FY-018 FY-571 FF-036 FF-087 FT-100 FV-021 FL-021 FF-623 FM-168 FM-100 FM-200 FF-405

OTROS COLORES CONSULTAR / OTHER COLOURS ON REQUEST / AUTRES COULEURS SUR DEMANDE / OUTRAS CORES PERGUNTAR

MESAS Y BANCOS PARA COMEDOR / TABLES AND BENCHES FOR DINING ROOMS /  
DES TABLES ET DES BANCS POUR SALLE À MANGER / MESAS E BANCOS PARA SALA



**Opción: Chasis de acero pintado**

Option: Chassis made of painted steel

En option: châssis en acier peint

Opção: Chassis em aço pintado

**Opción: Mesa y asiento de melamina**

Option: Table and seat made of melamine

En option: Table et assise en mélaminé

Opção: Mesa e assento de melamina

## MESA PLEGABLE

FOLDING TABLE  
TABLE PLIANTÉ  
MESA DOBRÁVEL



MOD. MP-2000  
COD. 99405

## BANCO PLEGABLE

FOLDING BENCH  
BANC PLIANTÉ  
BANCO DOBRÁVEL



MOD. BP-2000  
COD. 99406

### CARACTERÍSTICAS / CHARACTERISTICS / CARACTERISTIQUES / CARACTERISTICAS



COD.	MOD.	Plegado / Fold / Pliez / Dobrado					Desplegado / Unfold / Déplié / Desdoblado			
		↑↓	↔	↗↘	kg	M <sup>3</sup>	↑↓	↔	↗↘	↻
99405	MP-2000	930	110	770	16,5	0,078	760	1830	740	50
99406	BP-2000	260	100	930	9,0	0,024	430	1830	250	40

## SILLA PLEGABLE

FOLDING CHAIR  
CHAISES PLIANTE  
CADEIRA DOBRÁVEL



MOD. SP-900  
COD. 99408

## BANCOS Y MESAS PLEGABLES

FOLDING TABLE AND BENCHES  
TABLE ET BANCs PLIANTEs  
BANCOS E CADEIRAS DOBRÁVEIS



MOD. KP-1200  
COD. 99407



### CARACTERÍSTICAS / CHARACTERISTICS / CARACTERISTIQUES / CARACTERISTICAS



EPOXI



COD.	MOD.	Plegado / Fold / Pliez / Dobrado					Desplegado / Unfold / Déplié / Desdoblado			
		↑	↔	↗	kg	M <sup>3</sup>	↑	↔	↗	□
99408	SP-900	1100	470	250	5,0	0,018	900	450	420	-
99407	KP-1200	670	1160	120	20,5	0,088	690	1130	730	95
							420	930	230	40



**SECAMANOS ELÉCTRICO / ELECTRIC HAND DRYERS / SÈCHE-MAINS ELECTRIQUE / SECAMÃOS ELÉTRICO**



**MOD. OPTIC-2600**  
COD. 02600



**MOD. MUR-2500**  
COD. 03500



**MOD. SMP-3I**  
COD. 01700



**SECADORES DE PELO / HAIR DRYERS / SÈCHE-CHEVEUX / SECADOR DE CABELO**



**MOD. EXE-1200**  
COD. 02001



**DISPENSADORES DE PAPEL / PAPER DISPENSERS / DISTRIBUTEUR DE PAPIER / DOSIFICADOR DE PAPEL**



**MOD. DPCI-15000**  
COD. 15000

inox



**MOD. DPCA-20000**  
COD. 20000

ABS



**MOD. DPRI-25000**  
COD. 25000

inox



**MOD. DPRA-30000**  
COD. 30000

ABS



**CAMBIADORES DE BEBÉ / BABY CHANGING STATIONS / TABLE À LANGER BÉBÉ / MESA TROCA FRALDAS**



**MOD. PBABY-H**  
COD. 60900



**DISPENSADORES DE JABÓN / SOAP DISPENSERS / DISTRIBUTEUR DE SAVON / DOSIFICADOR DE SABÃO**



**MOD. DJ-I-INOX**  
COD. 00489

inox



**MOD. DJ-P-ABS**  
COD. 51001

ABS



**PAPELERAS EN ACERO / STEEL WASTEPAPER BINS /  
CORBEILLES A PAPIERS EN ACIER / LATA DE LIXO EM AÇO**



**MOD. PAP100**  
COD. 60010



**MOD. PAP900**  
COD. 60090 **inox**



**MOD. PAP 500**  
COD. 60100

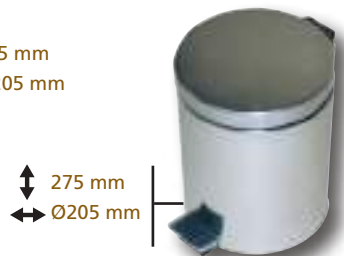

**MOD. PAP800**  
COD. 60800 **inox**



**MOD. PAP 5L ARO**  
COD. 60550

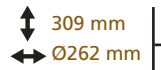

**MOD. PAP 11L ARO**  
COD. 60500



**MOD. PAP VIN**  
COD. 60570

**ACCESORIOS BAÑOS / BATH ACCESSORIES /  
ACCESSOIRES BAIGNE / ACCESORIOS BAHNO**



**MOD. PORTA-2**  
COD. 40300



**MOD. ESCOB-1**  
COD. 40400



**MOD. PSM-1**  
COD. 40500



**MOD. PER-1**  
COD. 40100



**MOD. PORTA-1**  
COD. 41100



**AYUDAS TÉCNICAS / TECHNICAL AIDS / AIDES TECHNIQUES / AJUDADES TÉCNICAS**



**MOD. ATR-1I**  
COD. 00300 **inox**

**MOD. ATR-1A**  
COD. 05909 **ABS**



**MOD. ATL-1A**  
COD. 06409 **ABS**

**MOD. ATL-1I**  
COD. 06509 **inox**



**MOD. AAP-ABS**  
COD. 01108 **ABS**

**MOD. AAP-INOX**  
COD. 01100 **inox**

**MOD. AT90-1A**  
COD. 60650 **ABS**

**MOD. AT90-1I**  
COD. 60070 **inox**







# TAQUILLAS PLÁSTICO

PLASTIC LOCKERS

VESTIAIRES EN PLÁSTIQUE

ARMÁRIOS EM PLÁSTICO

**CARACTERÍSTICAS / CHARACTERISTICS / CARACTERISTIQUES / CARACTERISTICAS**



Fabricado en PVC.  
Manufactured in PVC.  
Fabriqué en pvc.  
Fabricação em pvc.



Fácil limpieza.  
Easy cleaning.  
Nettoyage facile.  
Fácil limpeza.



Sin montaje.  
Without assembly.  
Pas de montage.  
Sem montagem.



Cerradura de llave.  
Standard key lock.  
Serrure standard à clé.  
Fechadura standard de chave.



Recomendado para ambientes húmedos.  
Resistente al agua. Waterproof.  
Recommandé pour les environnements humides.  
Recomendado para lugares com humidade. Resistente a água.

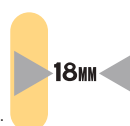

Espesores.  
Thicknesses.  
Épaisseurs.  
Espessura.



Fácil instalación de bandejas.  
Easy installation of the shelves.  
Montage facile des tablettes.  
Facil montagem de prateleiras.

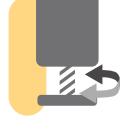

Patas regulables en PVC  
Adjustable PVC Legs  
Pieds réglables en PVC  
Pés reguláveis em altura em PVC



Gran resistencia.  
Great resistance.  
Très résistant.  
Muito resistente.



Cuerpo y puertas blanco.  
White body and doors.  
Corp et portes blanc.  
Corpo e portas branco.



Material antibacteriano.  
Antibacterial material.  
Matériel antibactérien.  
Material antibacteriano.



Rosetas de ventilación.  
Ventilation rosettes.  
Volets d'aération.  
Com ventilação.

**OPCIONES / OPTIONS / OPTIONS / OPÇÕES**



Pomo metálico (candado combinación opcional)  
Padlockable Metallic Lock (optional combination padlock)  
Poignée métallique (cadenas à combinaison en option)  
Fechadura de cadeado em metal

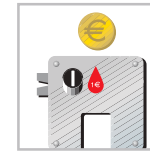

Monedero (moneda retornable).  
Coin-operated Lock (coin-return).  
Monnayeur (monnaie réversible).  
Moedeiro (moeda retornável).

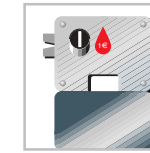

Monedero + cajetín depósito.  
Coin-operated Lock + Coin Collect Box (cash box, non coin-return).  
Monnayeur + tirelire (monnaie non réversible).  
Moedeiro + caixinha para as moedas.

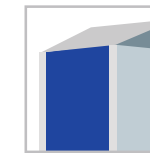

Sobretecho inclinado  
Slope Top  
Toit incliné  
Sobreteito com pequena inclinação



Zócalo PVC  
PVC Front Base and End Base  
Socle PVC  
Soco PVC



Divisoria vertical.  
Vertical center partition.  
Séparation vertical.  
Divisória vertical.



Cerradura de resbalón con bombillo extraíble y llave maestra.  
Latch operated lock with removable cylinder and master key.  
Serrure à plaquer avec cylindre enlevable et clé passe.  
Fechadura de segurança com possibilidade de tirar o cilindro e chave mestre.

**COLORES OPCIONALES PARA LA PERCHA, COLGADORES Y RESPIRADERO / OPTIONAL COLOURS FOR THE COAT ROD, COAT HOOKS AND VENTILATION OPENINGS/ COLORIS EN OPTION POUR LE TRINGLE PORTE CINTRES, LE CROCHET ET LE VOLET D'ÉRATION / OPÇÕES CORES PARA A BARRA O CABIDE E A VENTILAÇÃO DAS PORTAS**



REF. 01



REF. 02



REF. 03



REF. 04



REF. 05



# TAQUILLAS PLÁSTICO

PLASTIC LOCKERS  
VESTIAIRES EN PLÂSTIQUE  
ARMÁRIOS EM PLÁSTICO



PE



PV-40

PV-30

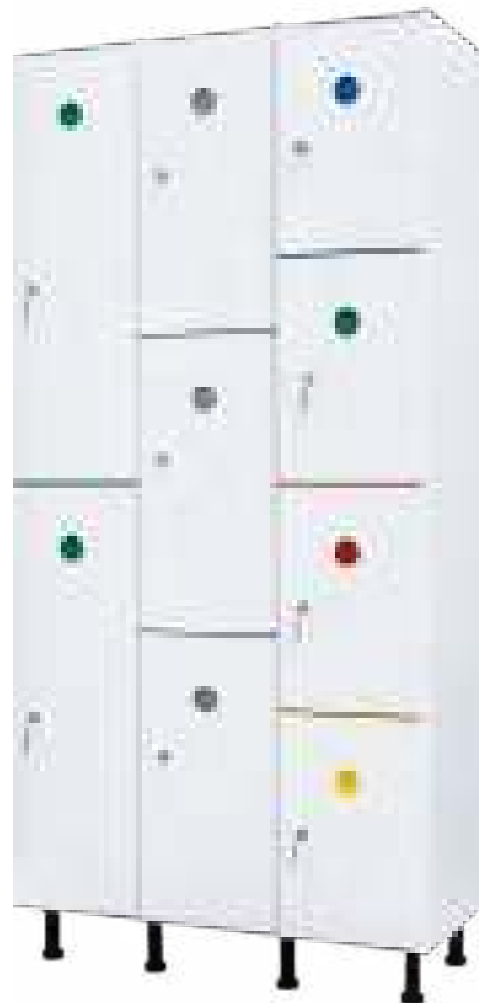

PT

PM

PC



PB

PZ

Divisoria vertical opcional.  
Option vertical center partition.  
Séparation vertical optionel.  
Divisória vertical opcional.

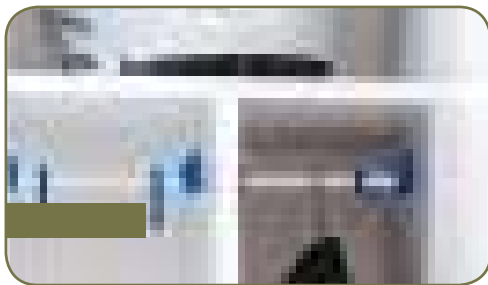

PV-40

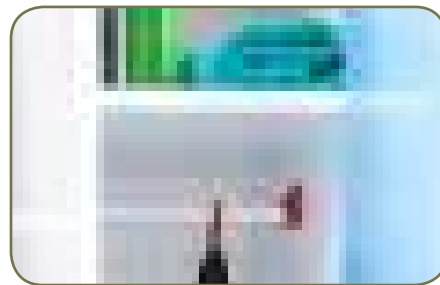

PV-30



PT-30



PE

SERIEPV

PV-30/1 COD. 22001 PV-30/2 COD. 22002 PV-30/3 COD. 22003 PV-30/4 COD. 22004 PV-40/1 COD. 22006 PV-40/2 COD. 22007 PV-40/3 COD. 22008

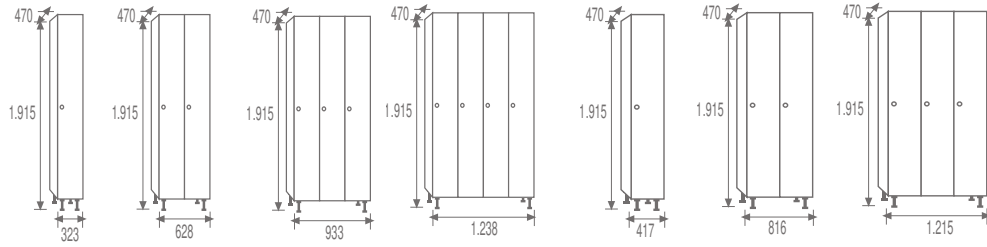

SERIEPT

PT-30/1 COD. 22011 PT-30/2 COD. 22012 PT-30/3 COD. 22013 PT-30/4 COD. 22014 PT-40/1 COD. 22016 PT-40/2 COD. 22017 PT-40/3 COD. 22018

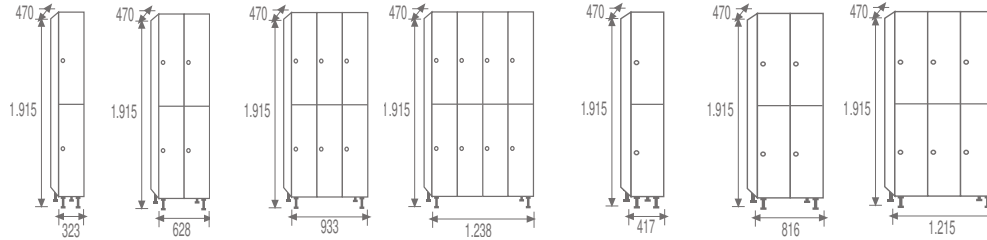

SERIEPM

PM-30/1 COD. 22021 PM-30/2 COD. 22022 PM-30/3 COD. 22023 PM-30/4 COD. 22024 PM-40/1 COD. 22026 PM-40/2 COD. 22027 PM-40/3 COD. 22028

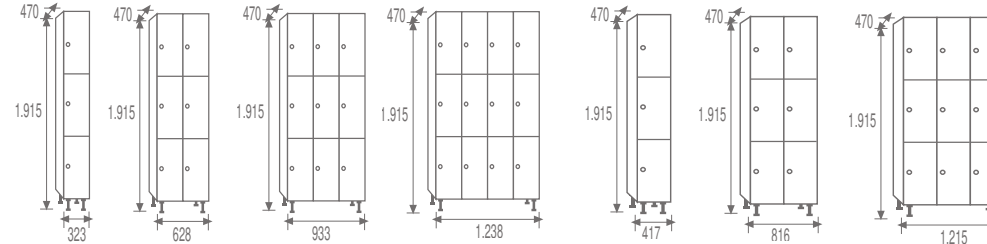

SERIEPC

PC-30/1 COD. 22031 PC-30/2 COD. 22032 PC-30/3 COD. 22033 PC-30/4 COD. 22034 PC-40/1 COD. 22036 PC-40/2 COD. 22037 PC-40/3 COD. 22038

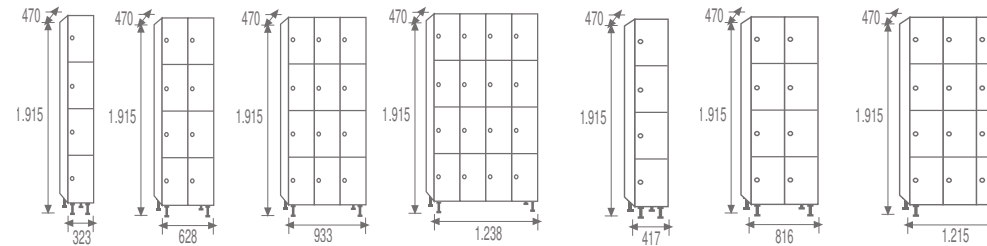

SERIEPB

PB-30/1 COD. 22061 PB-30/2 COD. 22062 PB-30/3 COD. 22063 PB-30/4 COD. 22064

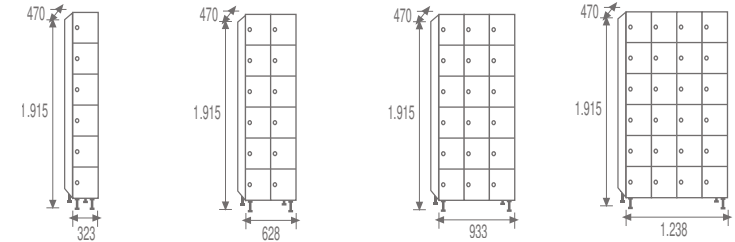

PB-40/1 COD. 22066 PB-40/2 COD. 22067 PB-40/3 COD. 22068

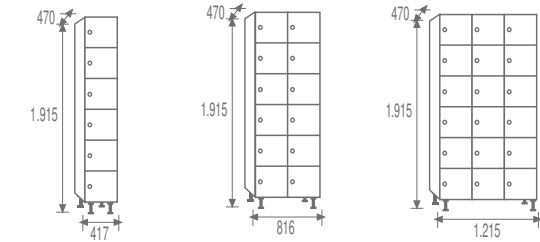

PZ-30/1 COD. 22081 PZ-30/2 COD. 22082 PZ-30/3 COD. 22083 PZ-30/4 COD. 22084

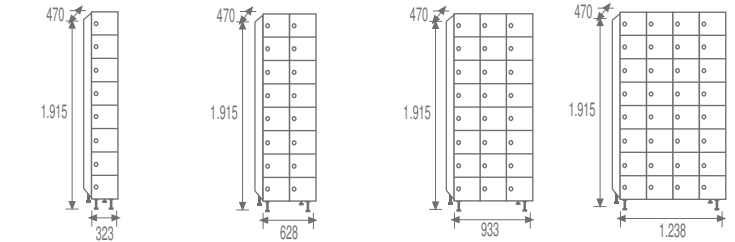

PZ-40/1 COD. 22086 PZ-40/2 COD. 22087 PZ-40/3 COD. 22088

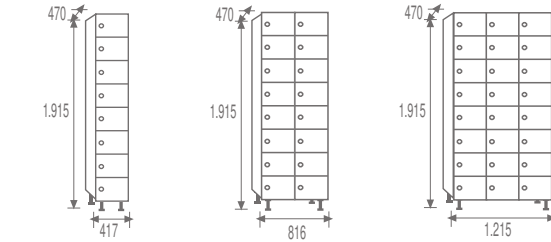

PE-70 COD. 22100

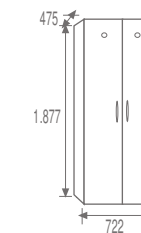

SERIEPZ

SERIEPE

## LOSETAS ENROLLABLES

ROLLED FLOOR TILE

DALLES ROULABLES

PAVIMENTOS QUE PODEM SER ENROLADOS

Polideportivos, gimnasios, vestuarios, piscinas...  
Sport centers, gymnasiums, changing rooms, swimming pools...  
Installations sportives, gymnases, vestiaires, piscines...  
Ginásios, vestiários, piscinas...

COLORES / COLOURS / COULEURS / CORES:

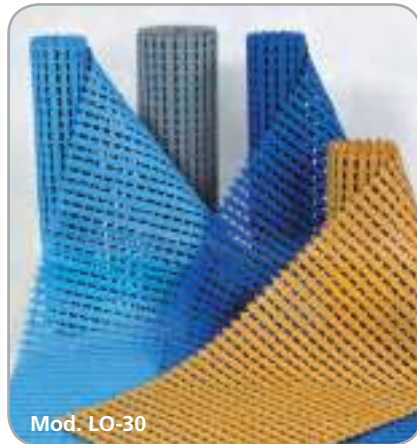

Mod. LO-30



### CARACTERÍSTICAS / FEATURES / CARACTERISTIQUES / CARACTERISTICAS

#### LOSETA ENROLLABLE DECO

• Dimensiones: 333 x 333 x 15 mm. • Peso: 500 Grs. • Material: Poliéstileno antideslizante EVA estabilizado. • Higiénica. Tratada con Sanitized, Antideslizante, Autoengarce, Sin Mantenimiento.

#### DECO ROLLED FLOOR TILE

• Dimensions: 333 x 333 x 15 mm. • Weight: 500 Grs. • Material: Non-skid Polyethylene stabilized EVA. • Hygienic. Sanitized treated, Non-skid relief, Self connection, Without maintenance.

#### DALLE ROULABLE DECO

• Measures: 333 x 333 x 15 mm. • Poids: 500 Grs. • Matériel: Poliéstileno antidérapant EVA stabilisé. • Hygiénique. Trató avec Sanitized, Antidérapant, Autofixation, Sans entretien.

#### PAVIMENTOS QUE PODEM SE ENROLAR DECO

• Dimensões: 333 x 333 x 15 mm • Peso: 500 grs • Material: Poliéstileno anti-escorregante EVA estabilizado • Higiénica. Esta tratada com Sanitized, Anti-escorregante, Montagem simple, Sem manutenção.

## PAVIMENTO CONTINUO DE VINILO

CONTINUOUS VINYL FLOORING

DALLAGE CONTINUU DE VINYLE

PAVIMENTO CONTINUO DE VINILO



Mod. SU-50 / SU-100

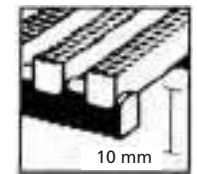

### CARACTERÍSTICAS / FEATURES / CARACTERISTIQUES / CARACTERISTICAS

- Drenaje multidireccional sumamente efectivo.
- Aditivos: bactericidas y estabilizantes ultravioletas.
- Efectivo en zonas interiores y exteriores.
- Ideal para pies descalzos y a la vez antideslizante.
- Resistente y de gran duración.
- Very effective multidirectional drainage.
- Additives: antibacterial and ultraviolet stabilizers.
- Ideal for barefoot and non-skid at the same time.
- Resistant and long-term.
- Drainage multidirectionnel très efficace.
- Additifs: bactéricides et stabilisants ultraviolets.
- Idéal pour pieds nus et antidérapant au même temps.
- Résistant et grande durée.
- Drenagem multidireccional muito efetiva.
- Adição: bactericidas e estabilizantes ultravioletas.
- Recomendado para zonas interiores e exteriores.
- Ideal para pés descalços e também é anti-escorregante.
- É muito resistente e de longa duração.



## LOSETAS RÍGIDAS GRID

RIGID FLOOR TILE

DALLES GRID

PAVIMENTOS GRID

Aplicaciones en industria pesada

Heavy industrial applications

Applications industrielles lourdes

Aplicações industriais pesadas

COLORES / COLOURS / COULEURS / CORES:



### CARACTERÍSTICAS / FEATURES / CARACTERISTIQUES / CARACTERISTICAS

- Dimensiones: 500x500 m/m.
  - Peso: 3,6 (abierta) o 4,4 (cerrada) kgs/m<sup>2</sup>.
  - Material: Polietileno.
  - No poroso. Resistente a la mayoría de ácidos, alcalinos y aceites.
- Dimensions: 500x500 m/m
  - Weight: 3,6 (open) or 4,4 (closed) kgs/m<sup>2</sup>.
  - Material: Polietileno
  - Non-porous. Resistant to most acids, alkalines and oils.
- Measures: 500x500 m/m.
  - Poids: 3,6 (ouvert) or 4,4 (fermé) kgs/m<sup>2</sup>.
  - Matériel: Polietileno.
  - Non poreux. Résistant à la plupart des acides, alcalins et huiles.
- Dimensões: 500x500 m/m
  - Peso: 3,6 (aberto) or 4,4 (fechado) kgs/m<sup>2</sup>.
  - Material: Polietileno
  - Não porosa. Resistente à maioria dos ácidos, álcalis e óleos.

## PAVIMENTO CONTINUO DE VINILO FLOORLINE

CONTINUOUS PVC FLOORLINE FLOORING

DALLAGE CONTINUU PVC FLOORLINE

PAVIMENTO CONTINUO DE PVC FLOORLINE

Polideportivos, gimnasios, vestuarios, piscinas...

Sport centers, gymnasiums, changing rooms, swimming pools...

Installations sportives, gymnases, vestiaires, piscines...

Ginásios, vestiários, piscinas...

COLORES / COLOURS / COULEURS / CORES:

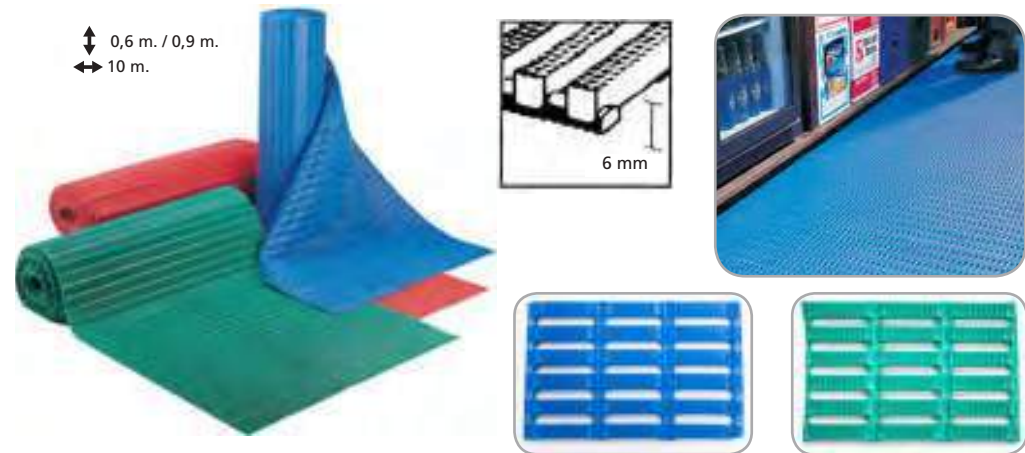

↑ 0,6 m. / 0,9 m.  
↔ 10 m.

6 mm

### CARACTERÍSTICAS / FEATURES / CARACTERISTIQUES / CARACTERISTICAS

- Drenaje multidireccional sumamente efectivo.
  - Aditivos: bactericidas y estabilizantes ultravioletas.
  - Efectivo en zonas interiores y exteriores.
  - Ideal para pies descalzos y a la vez antideslizante.
  - Resistente y de gran duración.
- Very effective multidirectional drainage.
  - Additives: antibacterial and ultraviolet stabilizers.
  - Ideal for barefoot and non-skid at the same time.
  - Resistant and long-term.
- Drainage multidirectionnel très efficace.
  - Additifs: bactéricides et stabilisants ultraviolets.
  - Idéal pour pieds nus et antidérapant au même temps.
  - Résistant et grande durée.
- Drenagem multidireccional muito efetiva.
  - Adição: bactericidas e estabilizantes ultravioletas.
  - Recomendado para zonas interiores e exteriores.
  - Ideal para pés descalços e também é anti-escorregante.
  - É muito resistente e de longa duração.



# ARMARIOS EN RESINA DE POLIPROPILENO

POLYPROPYLENE RESIN CUPBOARDS

ARMOIRES EN RESINE DE POLYPROPYLENE

ARMÁRIOS EM RESINA DE POLIPROPILENO



**MOD. RP-1**  
COD. 99101



**MOD. RP-2**  
COD. 99102



**MOD. RP-3**  
COD. 99103



**MOD. RP-4**  
COD. 99104



**MOD. RP-5**  
COD. 99105



**MOD. RP-6**  
COD. 99106



**MOD. RP-7**  
COD. 99107



**MOD. RP-8**  
COD. 99108

## CARACTERÍSTICAS / CHARACTERISTICS / CARACTERISTIQUES / CARACTERISTICAS



Se sirve desmontado.  
Delivered disassembled.  
Fourni démonté.  
Fornecemos tudo desmontado.



Recomendado para ambientes húmedos.  
Recommended for wet areas. Waterproof.  
Recommandé pour les environnements humides.  
Recomendado para lugares com humidade. Resistente a água.



Fácil montaje.  
Easy assembly.  
Montage facile.  
Facil montagem.



Tablero de resina de polipropileno.  
Panel made of polypropylene resin.  
Panneau en résine de polypropylène.  
Painel de resina de polipropileno.



Gran resistencia.  
Great resistance.  
Très résistant.  
Muito resistente.



Fácil limpieza.  
Easy cleaning.  
Nettoyage facile.  
Fácil limpeza.



# ARMARIOS EN RESINA DE POLIPROPILENO

POLYPROPYLENE RESIN CUPBOARDS

ARMOIRES EN RESINE DE POLYPROPYLENE

ARMÁRIOS EM RESINA DE POLIPROPILENO



RP-1 / RP-2



RP-3



RP-4



RP-5



RP-6



RP-7



RP-8

MOD. RP-1  
COD. 99101

MOD. RP-2  
COD. 99102

MOD. RP-3  
COD. 99103

MOD. RP-4  
COD. 99104

MOD. RP-5  
COD. 99105

MOD. RP-6  
COD. 99106

MOD. RP-7  
COD. 99107

MOD. RP-8  
COD. 99108

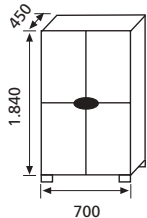

19,0Kg. • 0,22m<sup>3</sup>

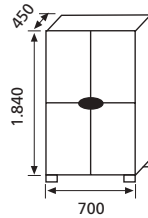

19,0Kg. • 0,22m<sup>3</sup>

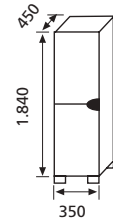

14,0Kg. • 0,14m<sup>3</sup>

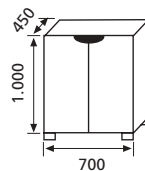

12,0Kg. • 0,14m<sup>3</sup>

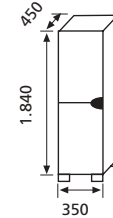

16,0Kg. • 0,14m<sup>3</sup>

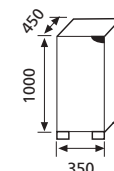

9,0Kg. • 0,8m<sup>3</sup>

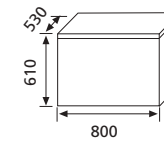

9,0Kg. • 1,0m<sup>3</sup>

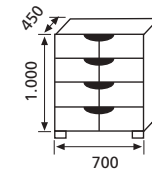

9,0Kg. • 1,0m<sup>3</sup>

Unidades en milímetros / Units in millimeters / Unités en milimètres / Unidades em milímetros

CERRADURAS / LOCKS / SERRURES / FECHADURAS



MOD. MCS1€  
COD. 90036

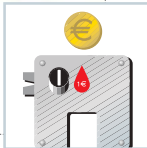

MOD. MMA1€  
COD. 90038

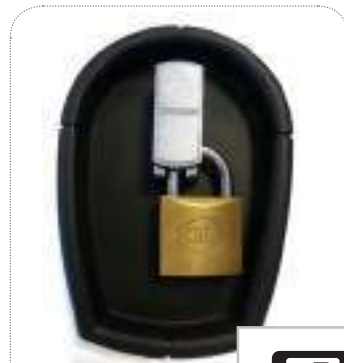

MOD. CERRPLA  
COD. 90065

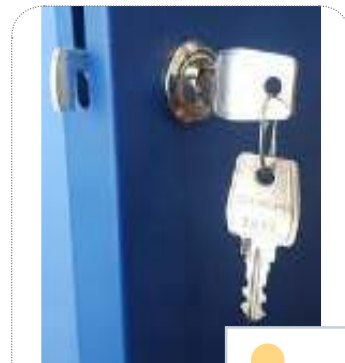

MOD. CERR.  
COD. 90080

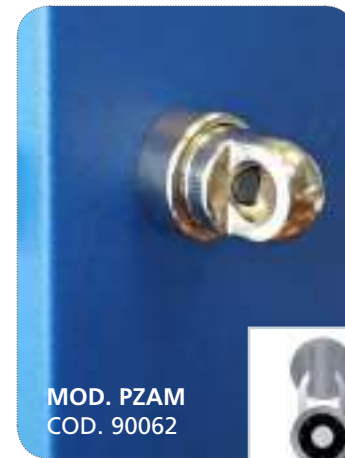
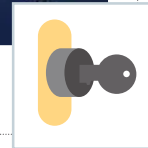

MOD. PZAM  
COD. 90062



MOD. CFALL  
COD. 90026



MOD. PPOL  
COD. 90025

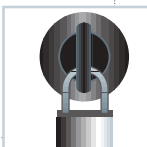

MOD. GPER  
COD. 99775



MOD. COMBI4D  
COD. 90520



MOD. CCOM45  
COD. 90060



MOD. CERRCAN  
COD. 90070



MOD. FALL  
COD. 90050



MOD. KITCE  
COD. 90074



MOD. CCOM40  
COD. 90061

CERRADURAS / LOCKS / SERRURES / FECHADURAS



**MOD. TELEC**  
COD. 90072



**MOD. ELOCK**  
COD. 90078



**MOD. PROXI 2**  
COD. 90076



**MOD. PAB.**  
COD. 90158



**MOD. WIFI**  
COD. 90090



**MOD. ENK**  
COD. 90200



**MOD. NEXT 1**  
COD. 90080



**MOD. NEXT 2**  
COD. 90081



**MOD. SOLA**  
COD. 90082



**MOD. PROXI 3**  
COD. 90095



# GESTIÓN INALÁMBRICA DE TAQUILLAS

WIRELESS LOCKER MANAGEMENT

GESTION DE CASIERS MOYENNANT WIFI

GESTÃO DE CACIFOS POR WIFI



## Beneficios

Benefits / Les Bénéfices / Vantagens

### GESTIÓN DE LAS TAQUILLAS A DISTANCIA, SIN CABLES ...

CONTROL REMOTO CON TABLET-PC, SMARTPHONE  
GESTIÓN SENCILLA  
CONTRÓL DE OCUPACIÓN  
RETORNO RÁPIDO DE LA INVERSIÓN  
CONTROL DE LOS INGRESOS  
MEDIO DE PUBLICIDAD

#### MANAGE LOCKERS AT A DISTANCE, WITHOUT CABLES ...

CONTROL WITH TABLET-PC, SMARTPHONE  
SIMPLIFIED MANAGEMENT  
OCCUPATION CONTROL  
QUICK RETURN ON INVESTMENT  
REVENUE CONTROL  
ADVERTISING MEDIUM

#### GEREZ LES CASIERS À LA DISTANCE, SANS FIL...

CONTRÔLE AVEC LE TABLET-PC, LE SMARTPHONE  
GESTION SIMPLIFIÉ  
CONTRÔLE DE L' OCCUPATION  
RETOUR RAPIDE SUR L' INVESTISSEMENT  
CÔNTROL DU REVENU  
SUPPORT PUBLICITAIRE

#### GESTÃO DE CACIFOS CONTROLE REMOTO, SEM FIO

CONTROLE REMOTO COM TABLET-PC, SMARTPHONE  
GESTÃO SIMPLES  
CONTROLE DE OCUPAÇÃO  
RETORNO RÁPIDO DO INVESTIMENTO  
CONTROLE DAS RENDAS  
MEIO DE PROPAGANDA

SERVICIO DE ATENCIÓN AL CLIENTE 24 H. (opcional)



24-HOUR CUSTOMER SERVICE (optional)

SERVICE CLIENT 24-HEURE (optionnel)

ATENDIMENTO AL CLIENTE 24 HORAS (opcional)

SEGURO  
SECURE  
SÛR  
SEGURANÇA







# Para / For / Pour / Para:

Parques de atracciones, Parques acuáticos, Museos, Universidades, Estaciones de ski, Gimnasios ...

Leisure Parks, Water parks, Museums, Universities, Ski stations, Fitness Centers ...

Parcs d'Attractions, Parcs Aquatiques, Musées, Universités, Stations de Ski, Centres de Fitness...

Parques de diversões, Parques aquáticos, Museus, Facultades, Estações de esqui, Academias ...



¿Por qué?  
Why?  
Pourquoi?  
Por quê?

**Porque la gestión diaria de la taquilla puede ser un problema.**

Because the daily management of the locker could become a problem.

Parce que la gestion quotidienne des casiers peut devenir un problème.

Porque a gestão diária do cacifo poderia se tornar um problema



**MEGABLOK®**

[www.megablok.com](http://www.megablok.com)

MEGABLOK®

# MEGABLOK®

[www.megablok.com](http://www.megablok.com)

Plataforma logística PLA-ZA, C/. Palermo, 7  
50197 ZARAGOZA (SPAIN)

Tels. (34) 976 50 54 88

Fax (34) 976 50 36 60

Móvil (34) 696 65 57 71

E-mail: [comercial@megablok.com](mailto:comercial@megablok.com)

France 01 84 88 40 46 Contactez nous